

Concurrent Show



Special Pavilion



January 24 –30, 2019 | Bangalore International Exhibition Centre

"My clear choice."



Titan Gilroy
TITANS of CNC: Academy, USA

Meet our coolant experts at our booth
A118 in Hall 3A and find out why Synergy 735
is the best metalworking fluid that Titan Gilroy
has ever used.

blaser.com/synergy735



Win a trip to Switzerland.



Enjoy a virtual visit to Switzerland at our **booth A118 in Hall 3A**, including a photo of yourself in front of a Swiss landscape as souvenir.

And with a bit of luck, you can win a trip to our head-quarters, where we will show you how our metalworking fluids can optimize productivity, economic efficiency and machining quality.

blaser.com

There will be no correspondence regarding the competition. The winners will be notified personally. Legal recourse is excluded.





Concurrent Show



Special Pavilion



January 24 –30, 2019 | Bangalore International Exhibition Centre

FAIRGUIDE



Published By



Indian Machine Tool
Manufacturers' Association

Venue



www.imtex.in

YCM[®]

S&T
GROUP
Since 1996

Advanced Double Column 5-axis Vertical Machining Center

DCV4030B-5AX

Equipped with ROBOI, high performance universal milling head, DCV4035B-5AX is specialized for applications demanding complex machining such as aerospace, automotive, medical and energy industries.

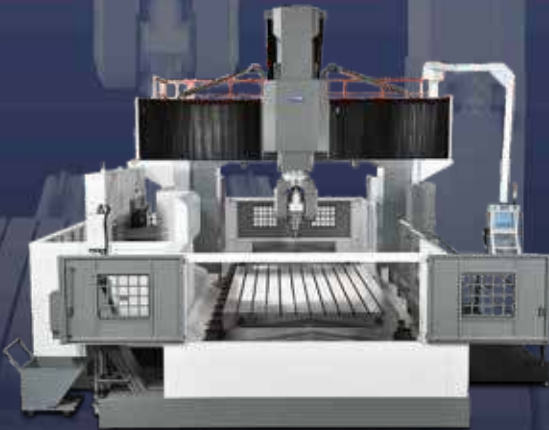

- **10,000rpm** Max. spindle speed
- **61.7HP** Max. spindle power
- **4 / 3.5 / 1 Meter** X/Y/Z travel
- **±110°** Swivel angle (B-axis)
- **±360°** Rotary angle (C-axis)
- **40T ATC** (60/120T optional)
- **20/20/15 Meter/min** X/Y/Z rapid feedrate
- **300°/sec.** Max. B/C-axis speed
- **44,092 lb** Max. load on table

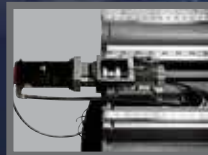

■ **Direct Drive Gearbox Design on X/Y/Z-axis**



■ **High Rigidity Roller Type Guideways**

- **High Dynamic Universal Milling Head with Built-in Motorized Spindle Design**
- **Direct Drive Motor Design on B/C-axis**
- **5-axis Simultaneous Control by HEIDENHAIN i-TNC530**

±110°/±360°
Swivel/Rotary angle (B/C-axis Angle)

300°/sec.
Max. B/C-axis Speed



IMTEX 2019

VISIT US AT
HALL - 2A, STALL NO - A106

for any further information call: 9894008111, Email: info@stengineers.com

Please visit us at IMTEX 2019

Live demo at Stall No. A-102, Hall 2B (German Pavilion)

Date : 24 January - 30 January, 2019

BIEC, 10th Mile, Tumkur Road, Bangalore

Industrial Quality Solutions



SPECTRUM

Coordinate Measuring Machine



COMET®

3D Scanners



O-SELECT

Digital Measuring Projector



O-INSPECT

Optical & Tactile CMM



RONDCOM NEX 200

Roundness measuring equipment



Stemi 508

Industrial Microscope



Car Body Solutions

In-Line Inspection System



Computed Tomography

2D & 3D X-Ray measurements



PiWeb Data Management

Industry 4.0 Platform

...and many more

Carl Zeiss India (Bangalore) Pvt. Ltd.

Plot No. 03, Jigani Link Road, Bommasandra Industrial Area, Bangalore 560 099



www.zeiss.co.in



info.metrology.in@zeiss.com



Visitor Registration

- IMTEX 2019 / Tooltech 2019 is a B2B Exhibition. Visitor registration is mandatory & free.
- Registration counters are located at the Entry Plaza 1 and Entry Plaza 2.
- Children below 10 years of age are not allowed.
- Wheel-chairs are available for handicapped visitors. Please contact Camp Office at Hall 2.

Parking Facilities

- Paid parking facilities are available.

Shuttle Bus (+91 8105001234 / +91 8105501234)

- Paid shuttle bus service from across Bangalore City to BIEC and vice-versa. Schedule & timings are incorporated in the Fair Guide.

Information Counters

- Information counters are located in all Hall 1A, Hall 2A, Hall 3A, Hall 4, Hall 5 & Hall 6

Business Centre (+91 934122 3862 / +91 99808 31340)

- Located at the entrance of Hall 1. Facilities available are photocopying, office stationery, telephone, fax, mobile rechargers, internet cards, courier, etc.

Food Court, Food Plaza, Garden Restaurant, Food Trucks & Snack Bar

- Take-away meals, beverages, fast-food, coffee, pizzas, etc at multiple locations across the Fair ground.

Tours & Travel, Left Luggage & Security Services

- Located at the Entry Plaza.

ATM & Florist

- ATM and florist boutique is located at the base of Entry Plaza.

Rest Rooms

- Available in all Halls and at Food Court & Entry Plaza.

Medical Services

- First-aid services are available at Entry Plaza.

Visitor's Security

- The visitor badge must be worn at all times and is not transferable.
- All the visitors are required to go through security check.
- Please co-operate with security personnel, as certain security procedures are followed for your safety.
- Please take care of your belongings. The organiser shall not be responsible for any theft or loss of your property.
- Please refer to the Emergency Response Procedure.
- In case of any emergency such as fire, oil leakage, or accident please call +91 8066246502 & +91 80 66246511.

BIEC IS 'NO SMOKING ZONE'





Visit us!
B101, H4

LASERTEC 30 SLM 2nd Generation

HIGH-PRECISION SELECTIVE LASER MELTING



OPEN SYSTEM

Individual adjustment of all
process parameter and free
choice of material supplier

DMG MORI PROCESS CHAIN

pre-machining and finishing on high-precision
machine tools from DMG MORI

rePLUG POWDER MODULE

- + Automated powder handling
with integrated powder
processing
- + change of material in
less than 2 hours

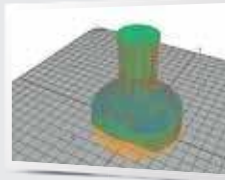

CELIS - INTEGRATED SOFTWARE SOLUTION

from CAM programming to
machine control



More about
ADDITIVE MANUFACTURING
dmgmori.com

DMG MORI

SHOW

FIRE EXTINGUISHER & WARDEN DETAILS

Location	Fire extinguisher type		Manpower
	ABC	CO2	
Hall 1A	9	4	1
Hall 1B	4	2	1
Hall 2A	9	4	1
Hall 2B	4	2	1
Hall 3A	11	4	1
Hall 3B	6	3	1
Hall 3C	4	2	1
Hall 4	9	3	1
Hall 5	9	4	1
Hall 6	5	2	1
Total	100	30	10

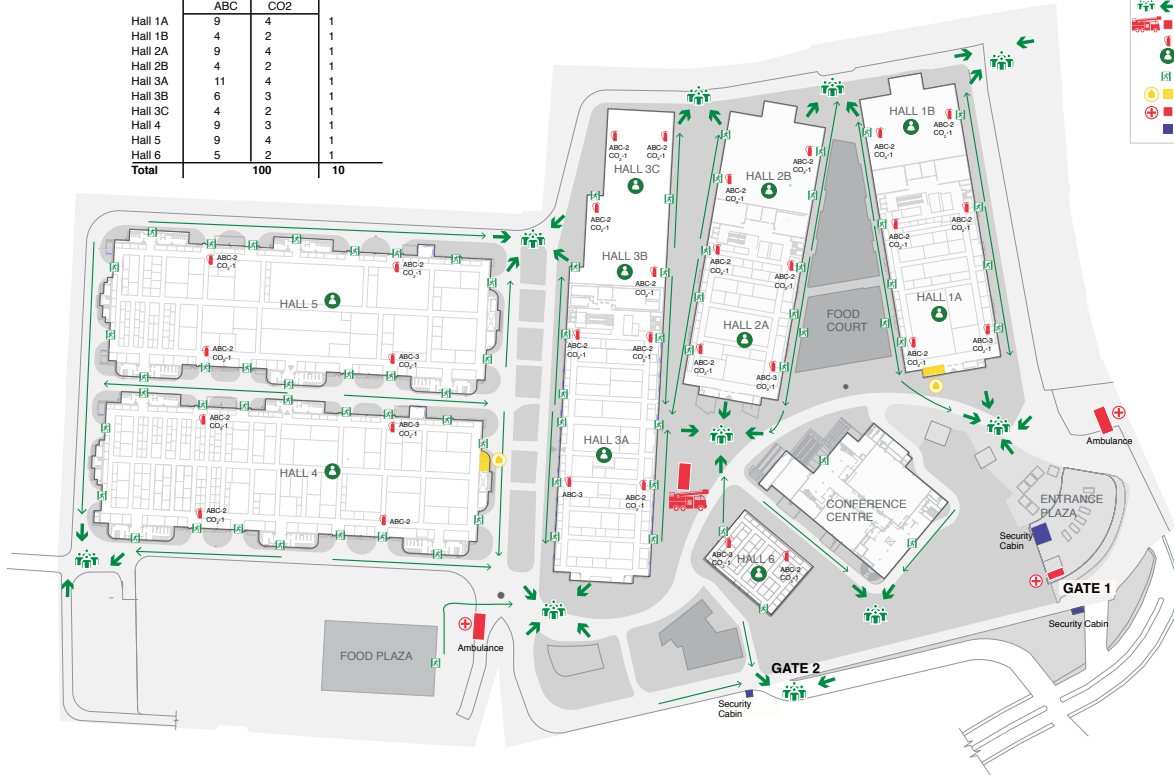

LEGEND

- Assembly Point (10)
- Fire Tender (1)
- Fire extinguisher
- Fire Warden
- Fire Exit
- Camp Office (2)
- Medical Facility (3)
- Security cabins (3)

Modular assistance system ToolScope



Together with our Partner KOMET® TYROLIT offers a comprehensive assistance system for your smart grinding process. ToolScope assists your production by utilizing machine signals without the excessive use of external sensors. Special apps help the end user to access and evaluate machine data, production data and process data in a simple manner.

For more information please contact:

TYROLIT India Superabrasive Tools PVT. LTD. | Phone: +91 80 2312 1811 | Email: sales-india@tyrolit.com



ATM



AMPHITHEATER



AMBULANCE



BUSINESS CENTER



CONFERENCE HALL



ENTRANCE PLAZA



EXIT GATE



ENTRY GATE



FIRE TENDER



PARKING



FIRST AID



FOOD COURT



FOOD PLAZA



GARDEN CAFE



HALL



INFORMATION



LUGGAGE COUNTER



LAGOON



REGISTRATION



REST ROOM



SECURITY OFFICE



TECHNOLOGY CENTER



R+W Couplings
HSD Spindles
Rotoflux Rotary Union



VISIT US AT
HALL - 1 A, STALL B-101

MARPOSS 4.0

THE SMART FACTORY TOGETHER



Industry 4.0 is a revolution that impacts every aspect of your business, and **Marposs** is the partner you need at your side each step of the way. **Marposs** solutions let you digitize everything from production to quality control, creating an interconnected network that generates the Big Data that puts you in command. Whether you're an early adopter or just starting your journey, **Marposs** is the partner you need to make **Industry 4.0** a working reality.



MARPOSS

www.marposs.com

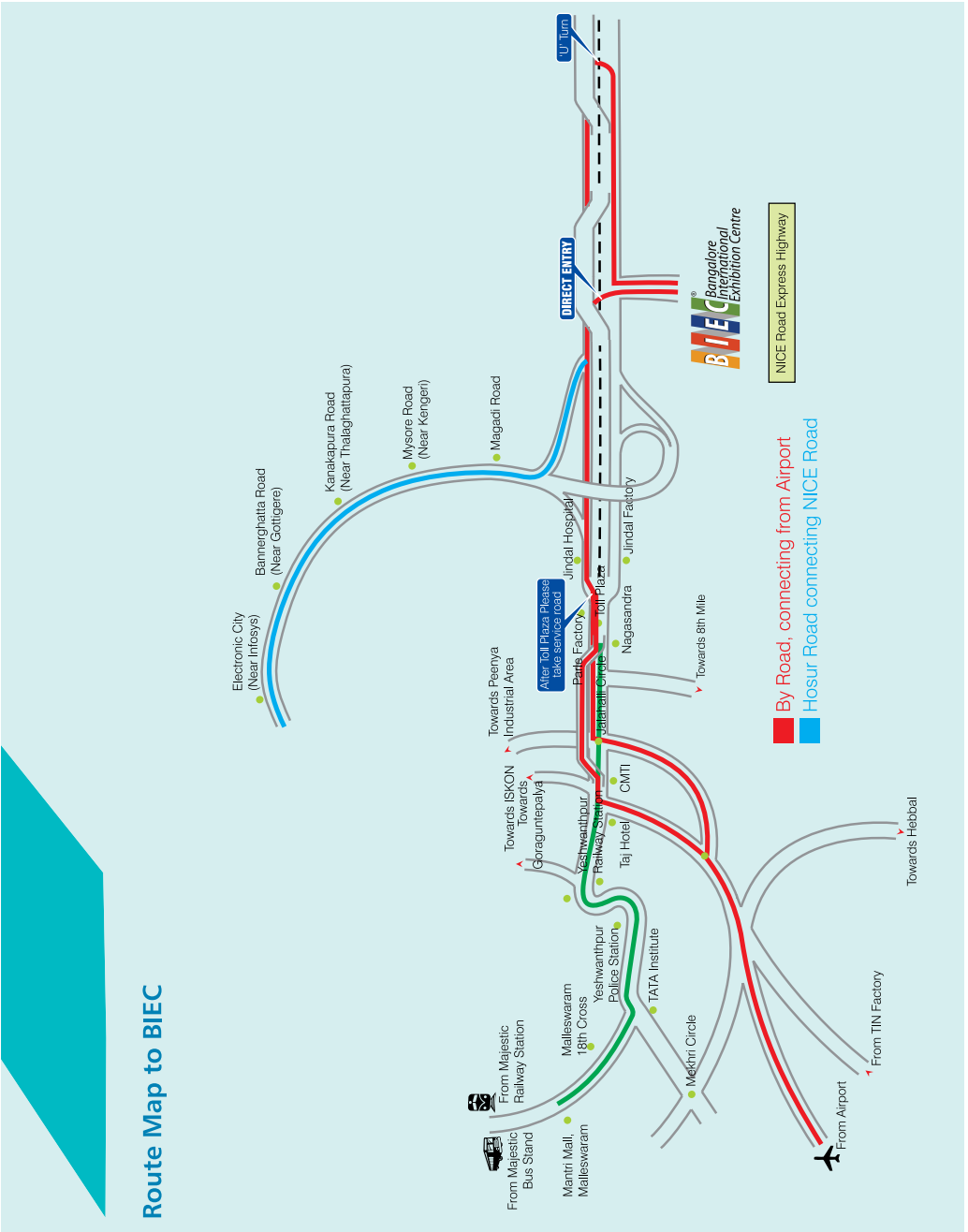

V P INDUSTRIES

Quality Speed Confidence

A Complete Tool Manufacturing Company



AGRICULTURAL EQUP.



POWER



AEROSPACE



OIL & GAS



AUTOMOBILE



GENERAL ENGG.

Visit us @

Hall No.
3B

Booth No.
A 110



VP

VP AERO

KOLHAPUR | PUNE | BELGAUM





**6 AXIS CNC GEAR
HOBBING MACHINE**

NOAH SERIES



**VISIT US AT
HALL - 1 A, STALL B-101**



2008 - 2018

mikro

Precision Test, Measurement
& Automation People

Visit us
C106 @Hall 5



ONE STEP SOLUTION FOR TESTING, MEASURING & ASSEMBLY AUTOMATION

INDIA
Mikro Innotech India Pvt Ltd
44/10, Narhe Industrial Estate,
Pune, Maharashtra 411041

sales@mikroindia.com
+ 91 - 8308 802 300
+ 91 - 9326 655 888
www.mikroindia.com

USA
Mikro EZ-Cam LLP
431 Kingston Court, Mount
Prospect, Chicago, IL 60056

maheshpatil@ezcamusa.com
USA + 1773 595 8274
INDIA + 91 - 8308 802 304
www.ezcamusa.com

THAILAND
Mikro Innotech Thai Co. Ltd
888/46, MOO 19, Bangplee,
Samutprakaran10540, Thailand

mikrothai@gmail.com
+ 66 - 9594 205 78
+ 66 - 9734 651 62
www.mikrothai.com

Local Support Offices :
Gurugram - North India
Chennai - South India
Bangalore - Hosur
Baroda - Gujarat

Company Name	Hall	Stall
A. R. Traders CNC	3C	C101
Abbott Toolfast Pvt. Ltd	5	B103
Abhi Fine Products	2A	A101
Abhijat Equipments Pvt. Ltd	2A	F101
Abro Technologies Pvt. Ltd	4	A117
Accu-fix Precision Tools Pvt. Ltd	4	B137
Accurate Engineering Company Pvt. Ltd	5	A126
Accurate Gauging & Instruments Pvt. Ltd	3A	B113
Accusharp Cutting Tools Pvt. Ltd	3A	F101
Ace Designers Ltd	5	B113
Ace Manufacturing Systems Ltd	5	A118
Ace Micromatic Group - Industry 4.0	6	A110
Ace Software Solutions Pvt Ltd - Industry 4.0	6	B111
AceMicromatic Manufacturing Intelligence Technologies Pvt. Ltd	5	B111
ACME Manufacturing Company	1B	A103
Acumac Machine Tools Pvt. Ltd	2A	B113
Addlife Coating Systems Pvt. Ltd	3C	D102
Advance Cooling Systems Pvt. Ltd	5	C152
Advanced Machine Tool Testing Facility (AMTTF)	4	C104
Agile Machineris Pvt. Ltd	1A	A116
Air Pel Technic	5	L102
Alex Machine Tools Pvt. Ltd	1A	A108
Alkon Plastics Pvt. Ltd	4	B144
Allied Machine & Engineering Corp.	1B	B102
Allmatic-Jakob Spannsysteme GmbH	2B	B106
Alok International Pvt. Ltd	3C	A112
Alstrut India Pvt. Ltd - Industry 4.0	6	G103
Altair Engineering India Pvt. Ltd - AME	6	A107
Altem Technologies (P) Ltd - AME	6	A119
Amace Solutions Pvt Ltd - AME	6	A110
Ambika Trading	5	K102
Ametek Instruments India Pvt. Ltd	3B	C106
AMT - The Association For Manufacturing Technology	3C	E101

Company Name	Hall	Stall
AMT - The Association For Manufacturing Technology	1B	C105
AMT Chennai Technology & Service Centre	1B	C107
AMT Group	5	C105
Anca Pty Ltd	4	C109
Andreas Maier Workholding Technology Pvt. Ltd	2B	B112
Anhui Huaxia Machine Manufacturing Co., Ltd	4	B128
Apar Industries Limited	3B	A123
Apex Dynamics (I) JV	5	C140
Apex Precision Mechatronix Pvt. Ltd	4	A137
Apm Technologies	2B	F105
Apsom Infotex Ltd	4	D103
APT Tools & Machinery India Pvt. Ltd	5	A138
ARK Machtek Pvt. Ltd	2A	C101
Arno & Prompt Toolings India Pvt Ltd	3C	B104
Arno Friedrichs Hartmetall GmbH & Co.KG	2B	D106
Arntz Techsaw Pvt. Ltd	1A	F107
Arrow Machine Tools	2A	E101
A-Ryung Machinery Ind.Co., Ltd	4	C132
Asapp Info Global Group / Equipment India	3C	D110
Ascent Intellimation Pvt. Ltd - Industry 4.0	6	G106
ASI DataMyte India Pvt. Ltd - Industry 4.0	6	D104
Askar Microns Pvt. Ltd	2A	B105
Association of Engineering Technology (SST)	3C	E109
Atlantic Lubricants & Specialities Pvt. Ltd	3B	C105
ATQ Metro	3B	A129
August Ruggeberg GmbH & Co. Kg - PFERD-Tools	2B	B110
Auram Machines (I) Pvt. Ltd	5	A111
Austin Engineering Company Ltd	5	B127
Autodesk India Pvt. Ltd - Industry 4.0	6	A112
Autogrip Machinery Co., Ltd	1B	E108
Avantec GmbH	2B	C104
Avi Oilless Die Components India Pvt. Ltd	4	B148



CLAMPING. SCREWING. LOCKING.

World leader in clamping...

Quality Since 1890



ANDREAS MAIER WORKHOLDING TECH. PVT. LTD.

(Subsidiary of : AMF - GERMANY)

Visit us at:
Hall No. 2B, Stall No. B112



Company Name	Hall	Stall
Axis Engineering Solutions	3B	C119
Axisco Precision Machinery Co., Ltd	1B	E110
B. R. Precisions	1A	A114
Baden-Württemberg International	2B	D111
Baker Gauges India Pvt. Ltd	3B	B105
Balance Systems Srl	1B	H101
Balluff Gmbh	2B	A114
Batliboi Ltd	1A	A105
Bayern International - Bavarian	2B	D102
BBW Brushes Pvt Ltd	5	G103
Beijing Ribbon International Exhibition Co., Ltd	3C	E111
Beijing Worldia Diamond Tools Co. Ltd	4	B126
Bemco Fluidtechnik LLP	3C	A101
Benco Thermal Technologies Pvt. Ltd	2A	B108
Benxi Tool Co.,Ltd	4	C131
Benz Gmbh Werkzeugsysteme	2B	C110
Bestek Engineering Pvt. Ltd	5	A105
Bhagwansons	5	B110a
Bhagwansons Engineers Pvt Ltd	5	B110b
Bharat Fritz Werner Ltd	1A	A102
Bhavi Impex	5	L103
Bhavya Machine Tools	5	B110c
Bielomatik Leuze GmbH + Co. KG	2B	C106
Big Zero Technology LLP - Industry 4.0	6	D106
Biltz Cutting Tools Company	3A	A137
Birla Precision Technologies Ltd	3A	B116
Blaser Swisslube India Pvt. Ltd	3A	A118
Blum-Novotest Measuring And Testing Technology Pvt. Ltd	4	C147
Bombay Tools Supplying Agency (P) Ltd	5	G102
Bosch Ltd - Industry 4.0	6	B115
Bosch Rexroth / Indeutsch Systems	5	A128
Botek Präzisionsbohrtechnik GmbH	2B	D103
Bowers Group	4	A122a
BPCS Pacific Speciality Petrochemicals Pvt. Ltd	5	H101

Company Name	Hall	Stall
Branson Ultrasonics	3B	D104
Breton SpA	4	A121
Brisk Tech Engineers	1A	B115
Broach Technology (India) Pvt. Ltd	1A	B112
Brother International India Pvt. Ltd	4	A102
Brugarolas India Pvt. Ltd	5	A144
Bruker Singapore Pte Ltd	3C	A110
BURKHARDT+WEBER Fertigungssysteme GmbH	2B	G102
C. & E. Fein GmbH	2B	B109
C. P. Agencies	4	L101
C.matic Spa	1B	H104
CAD Macro Design and Solutions Pvt. Ltd	3A	B120
CADEM Technologies Pvt. Ltd	5	F103
Camfil Air Filtration India Pvt. Ltd	5	B128
Canares Engineering Co	3B	C121
Capital Engineering Corporation	3B	C110
Carboline Toolings (India) Pvt. Ltd	5	F102
Carbotec India Pvt. Ltd	3C	B102
Carbtools (India) Pvt. Ltd	3B	A121
Carl Bechem Lubricants (India) Pvt. Ltd	3B	A105
Carl Zeiss India (Bangalore) Pvt. Ltd	2B	A102
Carmet Tools & Inserts	3B	B104
Carmex Precision Tools Ltd	3B	A126
Carr Lane Manufacturing Co.	3B	D101
CCPIT Machinery Sub-Council (CCPIT MSC)	3C	E121
Cemecon AG	2B	B116
Cenergy Offshore Private Limited	3C	C118
Central Manufacturing Technology Institute - Industry 4.0	6	B104b
Central Manufacturing Technology Institute (CMTI)	5	A122
Ceramed Engineers Ltd	2A	A115
CG Tech	1B	H106
Chain Headway Machine Tools Co. Ltd	1B	B110



**Please visit us at
Hall No. 4, Booth No. C147**

BLUM
focus on productivity

Blum Novotest Measuring & Testing Technology Pvt. Ltd.

+91 9353025005 | +91 7299086360 | +91 7028004451 | +91 7840008277

www.blum-novotest.com

Company Name	Hall	Stall
Changzhou City Wansui Tools Works	4	A132
Changzhou Guangxin Tools Co.,Ltd	4	P101
Changzhou Muladili Precision Cutting Tool Co., Ltd	3C	D122
Changzhou Xute Jifeng Tools Group Co.,Ltd	3C	D118
Chemetall India Pvt. Ltd	3B	C108
Chengdu Bangpu Cutting Tools Co.,Ltd	1B	A116
Chengdu B-to-O Superhard Materials Co.,Ltd	1B	G102
Chengdu Met-ceramic Advanced Materials Co.,Ltd	1B	B115
Chengdu Minjiang Precision Cutting Tool Co.,Ltd	1B	F106
Chengdu NEWKer CNC-Technology Co.,Ltd	1B	F104
Chengdu Tianhe Tungsten Carbide Tools Co., Ltd	1B	G103
Chennai Metco Pvt. Ltd	1A	A101
Chieftek Precision Co., Ltd.	1B	B109
China Machine Tool & Tool Builders Association (CMTBA)	3C	E102
Ching Hung Machinery & Electric Industrial Co., Ltd.	1B	A112
Chiron-Werke Gmbh & Co. Kg	4	A108
CHN-Top Sci & Tech Co.,Ltd	4	C118
Chrystec Machine Tools Pvt. Ltd	4	A123
Chum Power Machinery Corporation	1B	F101
Cimtrix Systems Pvt. Ltd	4	G104
CKD Corporation	4	A146
CKS Cable Solutions Pvt. Ltd	3C	C112
Clasys	4	J103
Cleantek	3A	B112
CMS SPA	5	B110d
CNC India Tools & Services Pvt. Ltd	1A	B116
CNC Times Pvt. Ltd	5	C160
Coburg Engineering Services Pvt. Ltd	5	A130
Conceptia Software Technologies Pvt. Ltd - Industry 4.0	6	G108
Concord United Products Pvt. Ltd	1A	C101

Company Name	Hall	Stall
Confederation of Indian Industry (CII)	3C	E115
Conprofe Technology Group Co.,Ltd	4	N101
Control And Framing Systems	3B	A127
Control Technics	2A	A109
Cosmos Digifac - Industry 4.0	6	B103
Cosmos Impex (India) Pvt. Ltd	5	B105
CP Grat - Ex Manufacturing Company	1B	B116
CPT GmbH	2B	F103
Craftsman Automation Pvt. Ltd	5	C111
Crane Bel International Pvt. Ltd	5	C109
Creative Engineering	2A	B103
Creintors Group	5	G101
Customised Technologies Pvt. Ltd	3B	C111
CY Carbide Mfg. Co., Ltd	4	M101
Daegu Gyeongbuk Machinery Cooperative (DGMC)	4	B145
Dahanukar Machine Tools	5	A119
Dalal Engineering Pvt. Ltd	2A	B109
Dalian Accut Machinery Co., Ltd	4	B125
Danobat Grupo Machine Tools India Pvt. Ltd	5	J101
Darshana Industries Pvt. Ltd	3B	A104
DBZ Technologies	5	C115
Dee-Kay Clutches Pvt. Ltd.	3C	C111
Delta Electronics India Pvt. Ltd	4	B141
Designcell CAD-CAM Solutions Pvt. Ltd - Industry 4.0	6	G102
Designtech Systems Ltd	4	C150
Dewan Housing Finance Corporation Ltd (DHFL)	5	A142
DHI - Samarth Udyog Bharat	6	B104
Diamond Abrasive Products	3B	A117
DIATOOOL Präzisionswerkzeuge GmbH	2B	A110
Dijet Industrial Co., Ltd	3A	C102
DJTOL Grinding Machine Group CO.,LTD	4	N106
DMG MORI India Pvt. Ltd	4	B101
Dolphin Exports	5	C114

PERFORMANCE
MEETS PRECISION

Visit us at
Hall 4
Stall No. A108

Company Name	Hall	Stall
Donaldson India Filters System Pvt. Ltd	5	A143
Dong San Ind Co., Ltd.	4	C122
Dongguan Baotn Machinery Co.Ltd.	1B	F102
Dongguan Chengda Machinery Technology Co.,Ltd	3C	D116
Dongguan Guoyi Precision Machinery Co.,Ltd	3C	D104
Dongguan Haolian Hardware Co., Ltd	3C	D105
Dongguan Qiandao Machinery Manufacturer Co., Ltd	4	F105
Dongguan Xinbang CNC Tools Co.,Ltd	1B	G101
Dongguan Yafeng Hardware Machinery Co., Ltd	3C	D104a
Doosan Machine Tools Co., Ltd	4	B102
Dormer Tools India Pvt Ltd	3A	B119
Dropco Multilub Systems Pvt. Ltd	5	A131
Drupe Engineering Pvt. Ltd	5	B104
Durga Bearings Company Pvt Ltd	4	S102
Dutch Tech Tools Pvt. Ltd	4	B135
DVS Technology Group	4	A107
Dyc Co.,Ltd	4	C136a
Dynascan Inspection Systems Company	3B	C103
Dynavac India Pvt. Limited	4	S101
Dynemach Systems Pvt. Ltd	3A	B144
Eagle Industries	1A	F101
East Coast Magnets Pvt. Ltd	2A	A112
Echaintool Industry Co., Ltd.	1B	A111
Eclipse Magnetics Ltd	4	A122
Ecoclean Machines Pvt. Ltd	4	B131
EFD Induction Pvt. Ltd	2A	B111
Ekin, S. Coop.	1B	B106
Electronica Hitech Machine Tools Pvt. Ltd	5	B116
Electronica India Ltd	2A	B107
Electronica Mechatronic Systems (India) Pvt. Ltd	5	A139
Elektromag Methods	3C	A116
Elesa And Ganter India Pvt. Ltd	3A	A115
EMAG GmbH & Co. KG	2B	A104
Erndeetec	4	H103
Emkay Tools	3A	A132
Emmppe Associates	3B	C130
Empire Machine Tools (MCAT Division)	4	B106
Endo Kogyo India Pvt. Ltd	2A	F105
Engis Corporation	1B	H107
EOS GmbH India Brach Office - AME	6	A106
Eppinger Tooling Asia Pvt. Ltd	2B	B114
Epson India Pvt. Ltd	4	C117
Eriez Magnetics India Pvt. Ltd	3C	C114
Erowa S.E.A Pte. Ltd	4	C142

Company Name	Hall	Stall
Erwin Junker Maschinenfabrik GmbH	2B	B113
ESPRIT by DP Technology	1B	B101
EST Tools Co.,Ltd	4	G101
ETA Technology Pvt. Ltd	5	A109
Exe-Tar, S.A.	1B	C106
EUCHNER GmbH + Co. KG	2B	D107
European Committee For Cooperation of the Machine Tool Industries (CECIMO)	3C	E103
Exact Machinery Co., Ltd	1B	B112
Exeron GmbH	2B	D109
ExxonMobil Lubricants Pvt. Ltd	5	C119
Factory Automation Technology Co., Ltd	1B	A110
Fagor Automation S.L.	1B	A106
Falcon Toolings	3A	A109
FANUC India Pvt. Ltd	5	B112
FANUC India Pvt. Ltd - Industry 4.0	6	F104
Farman Machinery Industry Co., Ltd	1B	A109
Faro Business Technologies India Pvt. Ltd	3A	B104
Felsomat India Pvt. Ltd	2A	B104
Felss Group GmbH	2B	A105
Fenwick and Ravi	1A	A106
Fermat Group, A.S.	4	B108
Ferro Foundries Pvt. Ltd	3B	C131
Festo India Private Limited	2B	A101
FFG MAG INDIA	4	B112
Fibro India Precision Products Pvt. Ltd	4	B146
Fittek India Pvt. Ltd	4	T102
Filtermist International Ltd	4	A122b
Fine Handling & Automation Pvt. Ltd	1A	B120
Fine Spavy Associates & Engineers Pvt. Ltd	4	J102
Finetech Toolings	3B	A125
FlexiCam GmbH	2B	D104
Fluid Logic Systems Pvt. Ltd	2B	B115
Fluro Engineering Pvt. Ltd	5	A106
Forbes & Company Ltd	1A	B109
Formosa Machinery & Equipment Pvt. Ltd	4	C119
Fracktal Works Pvt. Ltd - AME	6	A108
Francis Klein & Co. Pvt. Ltd	4	A106
Frankfurt Rhein Main GmbH	2B	D114
Fraunhofer - Industry 4.0	6	D105
Fuel Instruments & Engineers Pvt. Ltd (FIE)	5	C113
Future Technologies	3B	A114
Future Technologies - Industry 4.0	6	A116
Gala Precision Engineering Pvt. Ltd	2A	A114
Galaxy Chains Pvt. Ltd	3C	C105
Galaxy Machinery Pvt. Ltd	5	B119
Gedee Weiler Pvt. Ltd	2A	A104

Company Name	Hall	Stall
Geepax	4	C129
Geeta Machine Tools Pvt. Ltd	5	A104
Gehring Technologies GmbH	2B	C108
Gemini Power Hydraulics Pvt. Ltd	5	C154
General Imsubs Pvt. Ltd	4	R102
Geo Informatics Consultants Pvt. Ltd	3B	C126
German Machine Tool Builders Association (VDW)	3C	E108
GF Machining Solutions Pte Ltd	4	A124
GH Induction India Pvt. Ltd	1A	B111
GI India Automation And Systems Pvt. Ltd	5	A134
Gifu Enterprise Co., Ltd	1B	B111
Gindumac India Pvt. Ltd	3C	C106
Gishnu Gears	5	C115a
Givi Misure Pvt. Ltd	3B	A122
Gleason Works (India) Pvt. Ltd	5	A124
Globalnx Toolings Automation and Robotics Pvt Ltd	4	A116a
Globus Engineering Tools	3A	H101
GMN Paul Muller Industrie Gmbh & Co. Kg	2B	E105
GMT Global INC	4	C151
Gogate Electrosystems (N) Pvt. Ltd	3C	D111
Gole Precision Tools Pvt. Ltd	5	B123
Goodnews Measurement Cooperation Pvt. Ltd	3C	C107
Goodwill Precision Machinery Co., Ltd	4	E104
GOSTOL TST India Pvt.Ltd	3B	C132
Govt. of Karnataka	3C	E119
Gravotech Engineering Pvt. Ltd	1A	B118
Green Automation System	3B	C127
Grind Master Machines Pvt. Ltd	5	A101
GROB Machine Tools India Pvt. Ltd	4	A118
GSK CNC Equipment Co., Ltd	4	A131a
Guangdong Dagong Robot Co., Ltd	3C	D106
Guangdong Harvest Star Technology Co., Ltd	3C	D106a
Guangdong Juntai Hydraulic Technology Co., Ltd.	4	E106

Company Name	Hall	Stall
Guangdong Zhenshuo CNC Tools Co., Ltd	3C	B101
Guangzhou Haozhi Industrial Co., Ltd	4	B132
Gudel India Pvt. Ltd	2A	A110
Guenter Effgen Gmbh	2B	B108
Guhring India Pvt. Ltd	3A	A122
Guindy Machine Tools Ltd	4	A148
Gujarat Lathe Manufacturing Co. Pvt. Ltd	5	E101
Gurutzpe Turning Solutions S.L.	1B	C104
Haimer India Pvt. Ltd	3A	A104
Hangzhou Zhiguang Saw Industry Co.,Ltd	4	E102
Hansung GT Co.,Ltd	4	C124
Hardcastle Petrofero Pvt. Ltd	3C	C104
Hardinge Asia Ltd	1B	A102
Harting India Pvt. Ltd - Industry 4.0	6	E102
Hartner GmbH	3B	B101
Hawe Hydraulics Pvt. Ltd	4	A129
HCL Technologies Ltd - Industry 4.0	6	A114
Hebei Huayuan Machine Tool Accessories Co., Ltd	4	M108
Hegde Precision Engg Works	3C	A109
Heidenhain Optics & Electronics India Pvt. Ltd	3A	G101
Heimatec India Pvt. Ltd	4	A140
Heller India Pvt. Ltd	4	B119
Henan Bohong New Material Co.,Ltd	4	Q106
Henninger GmbH & Co.KG	4	C138
Hessen Trade & Invest Gmbh	2B	D114
Hexagon India Pvt. Ltd	3A	A112
Hi-Life Machine Tools Ltd	1A	B104
Hindustan Abrasive Technology	3C	C115
Hindustan Export & Import Corporation Pvt. Ltd (HEI)	4	A116
Hiwin Technologies Corp.	4	B110
HMB International - Gesac	3B	C109
HMT Machine Tools Ltd	5	B114
Hoffmann Quality Tools India Pvt. Ltd	3B	A112
Holroyd Precision Ltd	4	A116b

HURCO
mind over metal®

Visit us on Hall 4,
Stall C113

@ **IMTEX 2019**

Special offers on
Price, Finance & Delivery



- 01 3-AXIS VERTICAL MACHINING CENTER
- 02 TRUNNOV TABLE 5-AXIS MACHINING CENTER
- 03 SWFEL HEAD 5-AXIS MACHINING CENTER
- 04 CANTI LEVER TABLE 5-AXIS MACHINING CENTER
- 05 J & 5-AXIS HIGH SPEED MACHINING CENTER
- 06 BRIDGE TYPE 3 & 5-AXIS MACHINING CENTER
- 07 DOUBLE COLUMN 3 & 5-AXIS MACHINING CENTER

- 08 TRAVELLING COLUMN MACHINING CENTER
- 09 HORIZONTAL MACHINING CENTER WITH PALLET
- 10 HORIZONTAL MACHINING CENTER WITHOUT PALLET
- 11 HORIZONTAL BORING MILL CENTER
- 12 TURNING CENTER
- 13 TURNMILL CENTER
- 14 MULTI AXIS TURNING CENTER



For More Informations: Mohamed Arshad(South) - 96001 88566/Harshad Dongasankar(West) - 73587 76159/Mayank Tripathi(North) - 96600 17434

Company Name	Hall	Stall
Hong Ji Precision Machinery Ltd.	1B	F105
Honsberg Saws India Pvt. Ltd	5	A117
Hota Industrial Mfg.Co., Ltd	1B	E101
HP India Sales Pvt. Ltd. - Industry 4.0	6	B113
HPB Motion Control Co., Ltd	1B	F109
Humifogg Systems	3B	D102
Hurco India Pvt. Ltd.	4	C113
Hwacheon Asia Pacific Pte Ltd	4	C103
Hydac India Pvt. Ltd	2B	E102
Hytech Machine Tool & Automation India Pvt. Ltd	2A	F103
Ibarmia	1B	D105
ICEX- Spain Trade And Investments	1B	D101
Iec Air Tools Pvt. Ltd	3C	A103
Ifm Electronic India Pvt. Ltd	2B	A116
Ifm Electronic India Pvt. Ltd. - Industry 4.0	6	F102
Igus India Pvt. Ltd	3A	A117
IITD-AIA Foundation For Smart Manufacturing - Industry 4.0	6	B104c
Ilyich Abrasive Company	1B	H105
Imaginarium Rapid Pvt. Ltd - AME	6	D101
IMEXSU Group	1A	C102
IMI Machine Tools Pvt. Ltd	3B	A120
IMPEX World	3B	D105
Impression Systems and Engineers Pvt. Ltd	5	I103
IMTMA Technology Centre	1A	B102a
IMTMA Technology Centre	5	C104a
Incredible AM - AME	6	E103
Index-Werke Gmbh & Co. Kg	2B	C102
Indian Institute of Science - Industry 4.0	6	B104d
Indo Nihon Technologies	3A	A114
Indo-German Chamber of Commerce (IGCC)	2B	
Indotech Industries (I) Pvt. Ltd	2A	E103
Ind-Sphinx Precision Ltd UNIT B	3A	A106
Inductotherm (India) Pvt. Ltd	2A	B102
Infinon Advanced Laser Systems Pvt. Ltd	1A	A112

Company Name	Hall	Stall
Innovation Filter System Pvt Ltd	3A	A131
Innovative Automation Products	3B	B112
Inovatools Eckerle & Ertel GmbH	2B	A112
Insize India	3B	A111
Intech DMLS Pvt Ltd - AME	6	A111
Intelmac Machine Tools Pvt. Ltd	5	A120
Intouch Systems Pvt Ltd - Industry 4.0	6	B102
Ionbond Coatings Pvt. Ltd	4	A139
IPG Photonics (India) Pvt. Ltd	5	A128b
Iscar India Ltd	3A	B117
ISGEC Heavy Engineering Ltd - Industry 4.0	6	B105
Italian Technology Centre	1B	A107
ITL Industries Ltd	1A	D101
ITSAID Corporation	1B	A117
J. K. Machines	5	A110
J. N. Eberle & Cie. GmbH	5	B126
J. N. Tools	4	C146
Jagdeep Foundry (Regd.)	5	C122
Jagular Industry Ltd	1B	E104
Jai Balaji Control Gears Pvt. Ltd	3A	F102
Jain Diamond Tools / Gaurav Engineers	5	I101
Jain Precision Tools	5	C138
Janatics India Pvt. Ltd	3B	B109
Japan Machine Tool Builders' Association (JMTBA)	3C	E104
Jarng Yeong Enterprise Co., Ltd	1B	E106
Jash Precision Tools Ltd	3B	C113
Jenoptik India Pvt. Ltd	2B	A109
Jergens, Inc.	1B	B103
Jiangsu Hauto CNC Technology Co.,Ltd	4	C133
Jiangsu Swift Machinery Technology Co.,Ltd	4	F101
Jianye Group Co., Ltd	4	Q101
Jinagoudra Machine Tools Pvt. Ltd	5	C104
Jinan Golden Bridge Precision Machinery Co.,Ltd.	4	E103
Jinan Institute of Metallurgical Science Co., Ltd	4	M103



**YOU IMAGINE.
WE DELIVER.**

Every technology under one roof



 We are the first benchmarked partner for HP in Asia

 www.imaginarium.io



Offering the full spectrum of low-volume / batch manufacturing services using

- 3D Printing • Vacuum Casting • Soft Tooling
- CNC Milling • Injection Moulding

 +91 22 6738 0100  hello@imaginarium.io

Company Name	Hall	Stall
Jinan Sunrise CNC Machine Co.,Ltd	4	N105
Jinan XingTian Sunshine CNC Machine Co., Ltd	4	N104
Jinsheng Trading Dalian Co.,Ltd	4	E101
Jiuh-Yeh Precision Machinery Co., Ltd	1B	E103
Jokari-Krampe GmbH	2B	B104
Juaristi	1B	A108
Jyoti CNC Automation Ltd	5	B110
K Engg. Products	1A	A104
K. C. Precision	3A	B101
Kabelschlepp India Pvt. Ltd	3A	A107
Kapp GmbH & Co. KG	2B	G103
Kapsun Resources Corporation	3A	B106
Karcher Cleaning Systems Private Limited	3C	A114
Kasto Maschinenbau GmbH & Co. KG	2B	A115
Kelch GmbH	2B	C112
Kemtree Enterprises Pvt. Ltd	5	C142
Kendo By Forbes	3C	A104
Kennametal India Limited	1A	B103
Kenturn Nano. Tec. Co., Ltd	1B	B112a
Keyence India Pvt. Ltd	5	C121
KGD Co., Ltd.	4	C128
Khushbu Engineers	1A	B108
Kistler Instruments India Pvt. Ltd	4	C110
Kitagawa India Pvt. Ltd	3B	A106
KJF Co.,Ltd.	4	C136c
KJK MeisterHonen Pvt. Ltd	3A	A105
Klingelberg India Pvt. Ltd	4	A104
KNIPEX-Werk C. Gustav Putsch KG	2B	F104
Komatsu India Pvt. Ltd	4	B113
Komet / Ceratizit Group	3A	B115
KOMMA	4	C136b
Konig-mtm GmbH, Spanntechnik	2B	B107
Korea Machine Tool Manufacturers Association (KOMMA)	3C	E116

Company Name	Hall	Stall
Korloy India Tooling Pvt. Ltd	3A	A126
Kosmek Ltd	3B	C102
Kotec. Co. Ltd	4	C136
Krebs & Riedel Schleifscheibenfabrik GmbH & Co. Kg	2B	B111a
Krishna Engineering Works	5	C116
Krishna International	5	H104
Kristeel Shinwa Industries Ltd	3A	A135
KRS Multilub Pvt. Ltd	4	R104
KTA Spindle Toolings	4	A136
KTK Machines (India) Pvt. Ltd	5	A107
Kudale Instruments Pvt. Ltd	3A	B142
Kumbhojkar Plastic Moulders	5	C148
Kyocera CTC Precision Tools Pvt. Ltd	3A	A119
Kyocera SGS Precision Tools, Inc.	1B	A105
Laiyin Measurement Technology (Dong Guan) Co.,Ltd	4	F103
Lakshmi Digi Pro Systemz - Industry 4.0	6	G104
Lakshmi Electro Controls and Automation	4	C108
Lakshmi Machine Works Ltd	5	B106
Lapmaster Wolters India Pvt. Ltd	2A	B116
Laser Automation Pvt. Ltd - AME	6	A102
Laservall Technosolutions Pvt. Ltd	5	C110
Laxman Kadva & Sons Pvt. Ltd	1A	B113
Leanworx Technologies Pvt. Ltd - Industry 4.0	6	G101
Leistritz Produktionstechnik GmbH	2B	D110
Lex Technoaid Intenational Pvt. Ltd	3A	A111
Li-Chou Machinery Industry Co., Ltd	1B	E102
Lifeng Precision Tools (Zhejiang) Co.,Ltd	4	F104
Linear Ways India	3B	A109
LMT Tools India Pvt. Ltd	3A	A120
LNS Asia SA, Taiwan Branch	5	A137
Lokesh Machines Ltd	5	B102
Longkou Bluetooth NC Equipment Co., Ltd	4	C121
Losma India Pvt. Ltd	4	H101



Bore Accuracy up to One micron

**PRODUCTIVE BORE
FINISHING SOLUTIONS**
**CNC Single Pass
Honing Machine**

Available Products Range :

Single Pass Honing: SP150 / 250 / 350 / 450 / 650

Vertical Honing Machine: VH50 / VH750 / NH1500

Horizontal Honing Machine: MH/AH



Khushbu Honing

Collaborated with German Company

F24/1. M.I.D.C. Shirali, Kolhapur-416122, Maharashtra (IND.)

Ph: +91-230.2468859. Ph: +91 9371658016, +91 8149714625 E-mail: honing@khushbuindia.com Web: www.khushbuindia.com

Hall No.1A Stall No. B108

Company Name	Hall	Stall
Losma Spa	1B	A107
Lube Automatic Systems Pvt. Ltd	3B	C112
Lubi Industries LLP	5	B120
LUKAS-ERZETT Vereinigte Schleif- und Fraswerkzeugfabriken GmbH & Co. KG	2B	F102
Luoyang Hongyuan Bearing Technology Co., Ltd	4	Q103
Luthra Pneumys	3A	B140
M.S. Tools & Manufacturing Company Pvt. Ltd	3C	D101
Machine Elements	3B	B110
Machine House (India) Pvt. Ltd	2B	A111
Machine Tools (India) Ltd	4	B116
Machine Tools World	5	H103
Machinomatic Engineers	3C	B106
Maco Corporation (I) Pvt. Ltd	4	C114
MAG India Industrial Automation Systems Pvt. Ltd	4	B112
Magnus Lubricants Pvt. Ltd	4	B142
Mahr Metrology India Pvt. Ltd	2B	F101
Makino India Pvt. Ltd	5	B101
Malwa Machine Tools (India) Pvt. Ltd	2A	A107
Manar Tools Pvt. Ltd	5	A133
Manisha Machinery Pvt. Ltd	1A	A103
Mapal India Pvt. Ltd	2B	B103
Marksman	4	C112
Marposh India Pvt. Ltd	3A	B111
Marposh India Pvt. Ltd - Industry 4.0	6	B109
Marshall Machines Limited	5	B115
Marshall Machines Ltd - Industry 4.0	6	B108
Marvel Abrasive Tools	3C	C122
Maschinenfabrik Alfing Kessler GMBH	2B	A108
Mastercam - CNC Software, Inc.	1B	C101
Matrix Machine Tool (Coventry) Ltd	4	B117
Max Industries	5	F101
Mayr power transmission / Chr. Mayr GmbH + Co. KG	2B	A112a

Company Name	Hall	Stall
MEBA Metall-Bandsägemaschinen GmbH	2B	D105
Mechatronics Control Equipments India Pvt.Ltd	4	B139
Mechengg Industries	3B	C116
Meera Casting	5	H102
Mehta Cad Cam Systems Pvt. Ltd	2A	A111
Meiban Engineering Technologies Pvt. Ltd	5	C101
Metalcam Technologies Pvt. Ltd	3B	A128
MGM Engineering Corporation	4	C149
MIC Machine Tools Industries	5	A108
Micro Tooling Systems India Pvt. Ltd	5	C115b
Micromatic Grinding Technologies Ltd	5	A114
Micromatic Machine Tools Pvt. Ltd	5	A116
Microtech Machines	2A	A103
Microtek Grinding Machines Pvt. Ltd	2A	A119
Mikro Innotech India Pvt. Ltd	5	C106
Mikronix Gauges Pvt. Ltd	3B	A108
Millenia Technologies	3B	C120
Mimatic GmbH	2B	A112b
Minchuen Electrical Machinery Co., Ltd	1B	B113
Mitsubishi Electric India Pvt. Ltd	1A	B107
Mitsubishi Heavy Industries India Precision Tools Ltd (MHI-IPT)	4	A120
Mitsubishi Heavy Industries Machine Tool Co. Ltd	4	A120
Mitutoyo South Asia Pvt. Ltd	3A	B107
Miven Mayfran Conveyors Pvt. Ltd	3B	B103
M'La Sales Corporation	3A	A127
MMC Hardmetal India Pvt. Ltd	3A	A124
Mohanlal Ghanshmdas	5	C156
Mollart Engineering Ltd	4	C116
MST Corporation	3A	A130
MTE Industries Pvt. Ltd	5	B103a
Multicut Machine Tools	1A	B110
Multidimensions - AME	6	A118
Muvtons Castors Pvt. Ltd	4	B129
N.Gandhi & Co.	3C	A113



The Best Partner for Your Success

for a greener tomorrow

Technical Excellence
The next generation CNC ERG/MIRAMICRO Series empowers the manufacturing industry with unlimited possibilities and the capability to create innovative value.



Visit us at:
Hall 1A, Stall B107

www.MitsubishiElectric.in

MITSUBISHI CNC
THE CUTTING EDGE OF MACHINING CONTROL

Company Name	Hall	Stall
Narex Zdanice Spol. SRO	5	L101
National Institute of Design (NID)	3C	E113
Naxau new materials corporation	1B	G105
Neelkanth Power Solutions	5	F104
New Generation Tools	3C	D114
Next Generation 3D Printers Pvt. Ltd - AME	6	A109
NGCT Cleansys Pvt. Ltd	2B	G101
Nickunj Eximp Entp. P. Ltd	3A	A116
Nicolas Correa	1B	C102
Nikon India Pvt. Ltd	4	J101
Ningbo Limon Robot Co.,Ltd	4	G105
Ningyuan Machine Tool Pvt. Ltd	4	A111
Nissin Manufacturing Co.,Ltd	4	C115
Nitto Kohki Co., Ltd	3C	C119
NRB Industrial Bearings Ltd	5	A135
Octagon Precision (India) Pvt. Ltd	3A	A110
Oerlikon Balzers Coating India Pvt. Ltd	3A	E102
Oilmax Systems Pvt. Ltd	3A	B108
OKE Precision Cutting Tools Co.,Ltd	4	C135
Okuma India Pvt. Ltd	4	C111
OM Manufacturers	3B	C114
Omg Sri	1B	H102
Omkar Supranational Pvt. Ltd	5	C150
Open Mind Technologies AG	2B	E103
Orcan Products of India	3A	B134
Oriental Engineering Works Pvt. Ltd	2B	G104
Osaka Seimitsu Kikai Co., Ltd	5	B129
Osborn International GmbH	2B	E109
OSG (India) Pvt. Ltd	3A	C101
OTT- Jakob Spanntechnik GmbH	2B	E101
Otto Bilz (India) Pvt. Ltd	3A	A133
Pace Assembly Tools	4	T104
Pace India	3A	B124
Palmary Machinery Co., Ltd	1B	D102
Paragon Machinery Co., Ltd	4	A114
Patel Brass Turnomatics Pvt. Ltd	3B	C124
Patel Furnace & Forging Pvt. Ltd	1A	F103
Paul Horn GmbH	2B	A106
PDZI Europe GmbH	4	A152
Peiping Precision Enterprise Co., Ltd	1B	F107
Pelf Infotech Pvt. Ltd - AME	6	A103
Pepperl+Fuchs Factory Automation Pvt. Ltd - Industry 4.0	6	B112
Perfect Machine Tools Co. Ltd	4	A110
Perfect Magnets	3A	B110
Perform Coat Europe AG	4	B118

Company Name	Hall	Stall
Phillips Machine Tools India Pvt. Ltd	4	C101
Phoenix Contact (I) Pvt. Ltd	2B	B102
Pilana Metal S.R.O	4	B150
Pinnacle Engineering Enterprise	1A	F102
Pi-Tech Services	5	C158
PMT Machines Ltd	5	A103
Pneumec Kontrollis Pvt Ltd	3C	D107
Pointtech Co.,Ltd	4	C120
Polyworks Software India Pvt. Ltd	3A	A101
Pragati Automation Pvt. Ltd	5	B109
Prakash Engitech Pvt. Ltd	5	C102
Prash Machines	5	C128
Pratap Tex Chem Pvt. Ltd	3A	A103
Prayosha Enterprise	4	C140
Precihole Machine Tools Pvt. Ltd	5	C103
Precise Engineers	5	F106
Precision Machine Tool	5	C112
Precision Machinekraft Pvt. Ltd	2A	F104
Precision Motion Industries, Inc.	1B	A114
Precision Products Marketing Pvt. Ltd	5	H106
Precitec Precision Machineries Pvt. Ltd	5	B107
Pride Machine Tools Pvt. Ltd	1A	E101
Prime Precisions Pvt. Ltd	3C	B107
Prime Technologies	5	B135
Pro B Products	5	B121
Production Aids & Consultants Pvt. Ltd	5	C109a
Pro-Micron GmbH	2B	E107
Proteck Machinery Pvt. Ltd	4	B114
PSG Industrial Institute	2A	E102
Purshotam Company Pvt. Ltd	4	C102
Quaker Chemical India Private Limited	3A	B105
Quality Vision International, Inc (QVI)	1B	C103
Quick Shape Pvt. Ltd - AME	6	A105
Raj Petro Specialities Pvt. Ltd	5	B125
Rajamane Industries Pvt. Ltd	3B	B107
Rajasthan Udyog & Tools Pvt. Ltd	4	S104
Ramm Precision Products Pvt. Ltd	3A	B122
Rapid Coat Division	3B	C118
Rapid DMLS Inc. - AME	6	A104
Raplas India - AME	6	C102
Ratnaparkhi Electronics Industries Pvt Ltd	1A	E102
Ravik Engineers Pvt. Ltd	4	A119
Ravisons Corporation	2A	A121
Real Technologies Machines Pvt. Ltd	4	T103
Redington (India) Limited - AME	6	A117
Reliance Calibration Laboratory	3B	A115

Company Name	Hall	Stall
Reliance Engineering Company	3C	A111
Renishaw Metrology Systems Ltd	3A	B103
Renishaw Metrology Systems Ltd - AME	6	D102
Renuka Engineering & Service	5	C136
Riddhim Siddhim Steel India Pvt. Ltd	3C	C109
Rigbore India Pvt. Ltd	4	A138
Rishabh Power Components	3C	D112
Riya Electrodes Pvt. Ltd	3A	A113
Robin Precision Products Pvt. Ltd	3B	C122
Rocklin Manufacturing Co.	1B	A101
Rokade Rotek India Pvt. Ltd	3C	C113
Rollomatic SA	4	A101
Rollon India Pvt. Ltd	3B	C104
Rontgen Saws Pvt. Ltd	3C	D115
Roop Telsonic Ultrasonix Ltd	4	I102
Rose Plastic India Pvt. Ltd	4	B143
Rotodyne Fluid Technic	3C	C110
Royal Tech Engineers	5	C144
Rudrali Hitech Tools Pvt. Ltd	4	G102
RV Forms & Gears LLP - Industry 4.0	6	B107
S & T Group	2A	A106
S & T Machine Tools Pvt. Ltd	1A	B114
S. S. Tools India Pvt. Ltd	3B	D103
S.M. Systems Pvt. Ltd	5	C132
Saacke Machines & Tools Pvt. Ltd	4	A125
Sahajanand Laser Technology Ltd	2A	A108
Sajraj Technologies	2A	A113
Samarth Udyog Technology Forum-Industry 4.0	6	B104a
Samchully Machinery Co., Ltd	3B	B108
Samkrish	4	A142
Samkrish Machine Tools	4	B109
Samputensili Machine Tools	4	B120
Samtec Tools & Accessories Pvt. Ltd	3B	C115
Sandstorm Equipment Co.	1A	A109
Sandvik Asia Pvt. Ltd	3B	A102
Sandvik TDM - Industry 4.0	6	B101
Sanjay Tools & Adhesives	1B	B104
Sanpar Microfilters Pvt. Ltd	3C	D113
Sap Technical & Marketing Consultants	4	B104
Saveawatt Power Electronics Pvt. Ltd	3C	C103
SBC Linear co.,Ltd	4	C130
Schmersal India Pvt. Ltd	3B	A118
Schneeberger India Pvt. Ltd	3B	C117
Schwegler Werkzeugfabrik GmbH & Co. KG	2B	D108
SCT Tools	4	A150
Seedtec Machinery Co., Ltd	1B	F103

Company Name	Hall	Stall
Seoam Machinery Industry Co., Ltd	5	A141
Setco Spindles India Pvt. Ltd	3A	D102
Seventh International	2A	A116
SF Diamond Co., Ltd	4	C125
Shandong Best Precision Co., Ltd	4	G103
Shandong Shanyi CNC Machinery Co.,Ltd	4	M105
Shanghai Esuntek Machinery Co.,Ltd	4	A134
Shanghai Yuhe Diamond Tool Co., Ltd	4	P104
Shanxi Fengyuan Machinery Manufacturing Co., Ltd	4	Q105
Sharda Mechanic Works Pvt. Ltd	1A	E103
Sharp Industries	3A	B130
Shenoy Engineering Pvt. Ltd	1A	F105
Shenzhen William Automation Equipment Co.,Ltd	4	C123
Shilpa Enterprises	5	C146
Shilpin Machine Tools Pvt. Ltd	5	C108
Shin-ii Machinery Co.,Ltd.	4	C134
Shining Tools Ltd	3C	A106
Shobha Industries Pvt. Ltd	3C	A108
Shraddha Impex	5	A136
Shree Manjunath Engineering Precision Tools Pvt. Ltd	4	A131
Shree Rapid Technologies - AME	6	E101
Shuton, S.A.	1B	D103
Sichuan Machinery Imp & Exp. Corp Ltd	4	B134
Sichuan Province Neijiang Qinglonng Machine Tool Co., Ltd	4	Q108
Siddhi Precision Components & Accessories Pvt. Ltd	4	C154
Siemens Ltd	2B	B101
Siemens Ltd - Industry 4.0	6	F101
Sigma Engineers	3C	C102
Signage Products	5	C126
Sino Age Development Technology	4	Q105a
Sipcon Instrument Industries	3B	A101
SIT S.p.A	1B	H103
Sivenara Engineers	3C	D103
SKB Machine Tools	4	A103
SMC Pneumatics India Pvt. Ltd	5	B124
SMS Maschinenbau GmbH	2B	B105
SMW Autoblok Work Holding Pvt. Ltd	3A	B109
Society for Innovation and Development Innovation Centre (SID) / Indian Institute of Science (IISC)	3C	E120
Sodick Technologies India Pvt. Ltd	4	C107
Solar Diamond Tools (India) Pvt. Ltd	5	A127
Solidcam Software India Pvt. Ltd	5	B122

Company Name	Hall	Stall
Solitaire Machine Tools Ltd	1A	A113
Sovereign Syndicate	3A	B132
Sovereign Tech Engineering Services Pvt. Ltd	3A	A102
SP Leak Test and Automation Pvt Ltd	3A	B114
Span Filtration Systems Pvt. Ltd	4	C145
Sparknix (India) Pvt.Ltd	1A	B105
Speciality Urethanes Pvt. Ltd	4	C143
Spectrum Cutting Solutions Pvt. Ltd	4	K101
Speed Tiger Precision Tool Co., Ltd	1B	A119
Speedfam (India) Pvt. Ltd	2A	B110
Speurmac Engineering Services	5	C124
Sphoorti Machine Tools Pvt. Ltd	5	A129
Spinks Impex	2A	B106
SPM Tools	5	B118
Square Engineering Works	5	A121
SriYantra Engineers Pvt. Ltd	5	A102
SRS Technologies	3B	C128
Stamp IT Robotai & Solutions Pvt. Ltd	1A	A111
Stanley Black & Decker India Pvt. Ltd	3C	B103
Starrag India Pvt. Ltd	4	C105
State Engineering Corporation	3A	A129
Statfield Equipment Pvt. Ltd	5	G104
Staubli Tec Systems India Pvt. Ltd-Industry 4.0	6	B110
Steel-Smith	4	A135
Stellar Engineering	3C	B105
Sterling Abrasives Ltd	5	K101
Stitch Overseas Pvt. Ltd	4	A115
Strategi Automation Solutions Pvt. Ltd	2A	A117
Stroh Diamantwerkzeuge GmbH	2B	B111
Strub India Pvt. Ltd	3A	B102
Suave Engineering	2B	A113
Suhner India Pvt. Ltd	4	A127
Sundaram Finance Ltd	3C	D109
Sunita Engineering Corporation	1A	B106
Sunnen India Pvt. Ltd	4	A109
Suntech Landriani Machine Tools Pvt. Ltd	2A	B112
Sunus Tech Co., Ltd	1B	A113
Super Hobs & Broaches Pvt. Ltd	5	F105
Supply Point Systems Pvt. Ltd	4	C148
Suresh Indu Lasers Pvt. Ltd	5	B103b
Surhening Pvt. Ltd	3A	A108
Surya Machine Tools (India) Pvt. Ltd	5	C134
Suzhou Fulaike Cutting Tools Co. Ltd	5	B133
Suzhou Haller CNC Grinding Machines Co., Ltd	4	Q104
Swan Aluminiums Pvt Ltd	5	A140
Swastik Engineers	1A	A107

Company Name	Hall	Stall
Swastik Overseas	4	A113
Swift Industrial Agencies	3C	C117
Swift Industrial Corporation	3B	C125
Sylvac SA	3A	B127
System Controls Technology Solutions Pvt. Ltd	3C	A102
Systemantics India Pvt. Ltd	5	A123
TaeguTec India Pvt. Ltd	3A	A128
Taguti Industrial Limited	4	E105
Taicin L. S. Co., Ltd	1B	A115
Taiwan Association of Machinery Industry (TAMI)	3C	E110
Taizhou Beijing Machine Tools Co.,Ltd	4	B123
Taizhou Xi-Tong Tool Co.,Ltd	1B	G104
Taizhou Zhongyu Thread Rolling Tools Co., Ltd	4	R103
TAL Manufacturing Solutions Ltd	2A	B114
Talleres Gamor	1B	B105
Tasa Micro SPM Pvt. Ltd	5	A128a
Tech Mech Handling Equipment	3A	A121
Tecnicrafts Industries	4	B133
Tecnologie FRB Srl	4	B127
Tectyl Oil and Chemical (India) Pvt. Ltd	3B	C123
Tekcel Automation Pvt. Ltd	5	C107
Teknic Euchner Electronics Pvt. Ltd	2B	C101
Teknomec	5	A112
Tekesai Systems	3C	C116
Tenryu Saw India Pvt. Ltd	3B	A103
Termmei Torch & Tip Company	4	A126
Tespa Tools Pvt. Ltd	4	H102
The All India Plastics Manufacturer's Association (AIPMA)	3C	E122
The M. K. Morse Company	3B	C129
The Manufacturing Technologies Association (MTA)	3C	E105
The Mexican Association of Machinery Distributors (AMDMD)	3C	E106
The New Ball Bearing Co.	3C	B108
Thielenhaus Technologies GmbH	4	B115
THK India Pvt Ltd	3B	B106
Three Digi Prints - AME	6	A101
Tisa Enterprises	4	S103
TMC Measuring Instruments Pvt. Ltd	2B	E104
Tool and Gauge Manufacturers Association (TAGMA)	3C	E114
Tool Grinding Technologies Inc.	2A	D101
Toolcraft Systems Pvt. Ltd	2A	A105
Tooltech Industries	4	C144
Tosei Engineering Pvt. Ltd	3A	D103
Toshiba Machine (Chennai) Pvt. Ltd	4	L102

Company Name	Hall	Stall
Toyoda Micromatic Machinery India Pvt. Ltd	5	B108
Transtech Gears Pvt. Ltd	3A	B138
Trevisan Macchine	4	A112
Tribotech	3C	C120
Trio Motion Technology Ltd	4	B107
Trishul Machine Tools Pvt. Ltd	1A	A110
Tropicool enovations and Cooling Systems	4	B127
Trumpf (India) Pvt. Ltd - AME	6	D103
Tschudin AG	4	C106
Tsi Power Pvt. Ltd	5	B120a
Tsudakoma Corp.	3A	E103
Tsugami Precision Engineering India Pvt. Ltd	2A	B101
Tumakuru Machine Tool Park (TMTP)	2A	A101a
Tung Pei Industrial Co., Ltd	1B	B114
Tungaloy India Pvt. Ltd	3A	B123
Turnmax Machine Tools	3A	B128
Tussor Machine Tools India Pvt. Ltd	5	A113
Tyrolit India Superabrasive Tools Pvt. Ltd	3B	A116
UBTECK Carbide	3C	C108
UCAM Pvt. Ltd	1A	B101
Ucimu-Sistemi Per Produrre (UCIMU)	3C	E107
Ultramax Hydrojet Pvt. Ltd	5	H105
Unique Industries (India)	3B	A124
Unique Saws & Machinery Pvt. Ltd	1A	A115
United Grinding Group Management AG	4	B103
Unity Controls Pvt. Ltd	5	A132
Unity Gauge & Tool Co. Pvt. Ltd	5	C117
Universal Abrasives	3A	B126
Universal Engineering & Manufacturing Industry	3A	D101
Universal Metrology & Allied Services	4	I101
Uptech Engineering	3B	A107
Usha Fasteners Pvt. Ltd	4	A144
U-Tech Associates	3A	E101
V. M. Traders	5	I102
V. P. Industries	3B	A110
V. V. Engineering Works	1A	A117

Company Name	Hall	Stall
Vargus Ltd	3B	B102
Veekay Industries	3A	B136
Veeraja Industries	5	B131
Vekttek, LLC	1B	H108
Venus Automation Pvt. Ltd	1A	F104
Vigel Manufacturing Technologies Pvt. Ltd	2A	A102
Vijay Gears	4	T101
Vijayshree Wear Parts Pvt. Ltd	3B	A113
Vimana	6	B106
Vinpak Machines Pvt. Ltd	5	C118
Vision Embesoft Solution	1A	F106
Viswa Engineering Traders	4	D101
Voestalpine High Performance Metals India Pvt.Ltd	3C	A105
Vollmer Technologies India Pvt. Ltd	2B	F107
VPS Technology India Pvt. Ltd	5	A125
VSM Vereinigte Schmirgel- und Maschinen-Fabriken AG	2B	A107
VT Tools Pvt. Ltd	3B	A119
VW Mosbach CNC Technologies	5	C130
Warrier Electronics	4	K103
Wave Tools & Technologies	2A	F102
Weidmuller Electronics India Pvt. Ltd	2B	A118
Weiler Abrasives GmbH	2B	B117
Wendt (India) Ltd	5	B117
Wenling Miaoxin Trading Co.,Ltd	4	N103
Wenzel South Asia Pvt. Ltd	4	C152
Wickman Machine Tools India Pvt. Ltd	4	A105
Widin Co., Ltd	3C	A107
Wikus-Saegenfabrik GmbH & Co. KG	2B	D112
Willemin-Macodel SA	4	D102
Wintegral Engineering Pvt. Ltd	4	K102
Wol 3d - AME	6	A113
Wood Craft	3C	D108
WTO GmbH	3A	A125
Wuxi Zhouxiang International Trade Co Ltd	4	B124
Xceed Toolings Pvt. Ltd	3B	C101



**HIGH SPEED
HIGHER CLAMPING TORQUE**



ALL NEW URX SERIES

**VISIT US AT
HALL - 1A, STALL B-101**

Company Name	Hall	Stall
Xinxiang SKF Machinery Co., Ltd	4	M106
XL CNC Machines	5	A115
Xtreme Gaming Pvt. Ltd	4	C155
Yamazaki Mazak India Pvt. Ltd	4	B105
Yamazaki Machinery & Tools India Pvt. Ltd	4	B111
Yangzhou RZF IMP and EXP Co., Ltd	4	M104
Yangzhou Soar Machine Tool Co.,Ltd	4	F102
Yash Machine Tools	4	A133
Yeshwant Industries	4	A133a
YG Cutting Tools Corporation Pvt. Ltd	3A	B121
YG Tech Co.,Ltd.	4	C126
YH Tools Manufacturers	3A	B118
Yih Troun Enterprise Co., Ltd.	1B	E105
Yiyou CNC Tools (Guang Dong) Co.,Ltd	1B	F110
Young Buhmwoo India Company Pvt. Ltd	4	C153
Yugma Impressions	5	B110e
Yuhuan CNC Machine Tool Co.,Ltd	4	N102
Yuken India Ltd	4	I103
Zaverin Daubert India Private Limited	3A	B125
Zayer	1B	B107
Zeal Tech Automation	1A	B102
Zecha Hartmetall-Werkzeugfabrikation GmbH	2B	D101
Zentron Labs Pvt. Ltd - Industry 4.0	6	B117
Zhejiang Ivke Machinery Technology Co., Ltd	3C	D120

Company Name	Hall	Stall
Zhejiang Jinglu Tools Co., Ltd.	4	B130
Zhejiang San Ou Machinery Ltd. Company	4	A128
Zhejiang Ute Bearing Co., Ltd	4	F106
Zhejiang Weilishi Machine Co., Ltd	4	R101
Zhejiang Xinxing Tools Co., Ltd	4	C127
Zhejiang younio Tools Co., Ltd	4	P103
Zhengzhou Berlt Hard Materials Co., Ltd	4	B122
Zhengzhou Diamond Precision Manufacturing Co., Ltd	4	B121
Zhengzhou Zhongnan Jete Superabrasives Co., Ltd.	4	M102
Zhuzhou Cemented Carbide Cutting Tools Co., Ltd	4	B136
Zhuzhou Huarui Precision Cutting Tools Co., Ltd	4	C139
Zhuzhou Jinte Cemented Carbide Co., Ltd	4	C141
Zhuzhou Meetyou Cemented Carbide Co., Ltd	4	Q107
Zhuzhou Ruideer Metallurgy Equipments Co., Ltd	4	P102
Zhuzhou Sant Cutting Tools Co.,Ltd	4	A130
Zhuzhou Xinhua Cemented Carbide Industrial Co., Ltd	4	C137
Zigong Haoxin Tool Materials Liability Co., Ltd	4	Q102
Zigong Xili CNC Tool Co., Ltd	1B	F108
Zimmer Automation LLP	2B	A103
Zoller Singapore Pte. Ltd	3B	C107
Zollern GmbH & Co. KG	2B	D113

THE
KNOW-
HOW
FACTORY





Visit our Booth at
Hall No. 2B, Stall No. A103

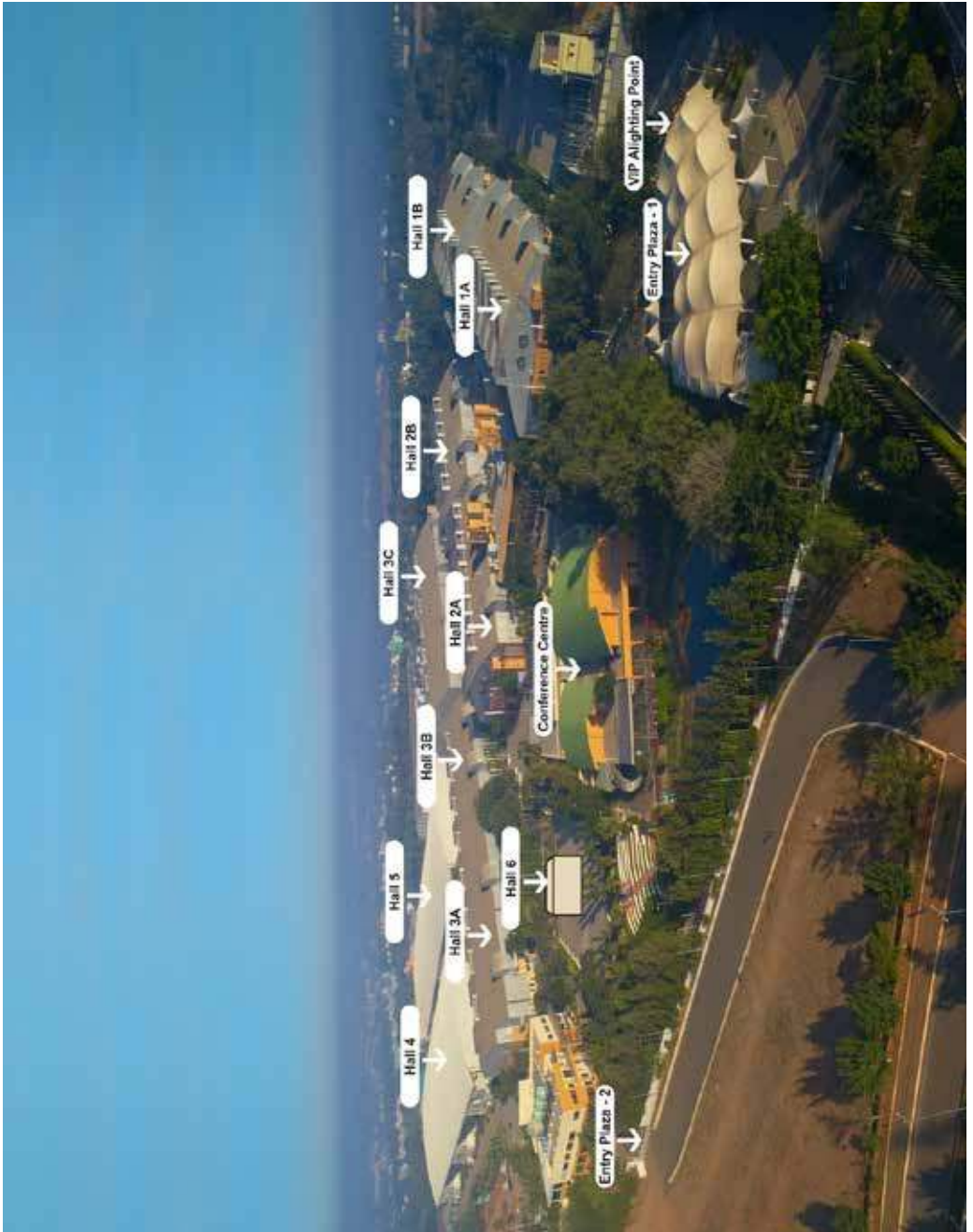

Hall 1A

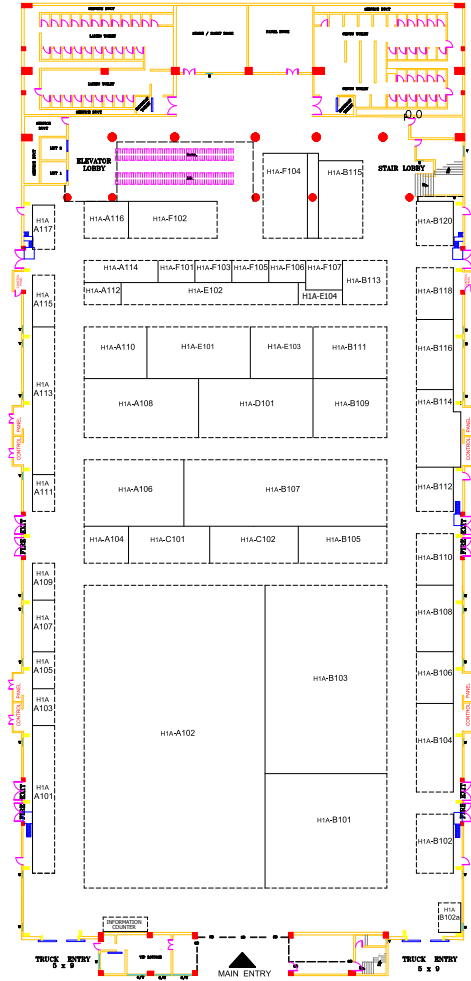

MITSUBISHI ELECTRIC
Changes for the Better

The Best Partner for Your Success

for a greener tomorrow

Intrinsic PowerStays
The next generation CNC EB04/MR04/MR03/C03 Series empowers the manufacturing industry with unlimited possibilities and the capability to create innovative value.



IMTEX 2019

Visit us at:
Hall 1A, Stall B107

MITSUBISHI CNC
THE CUTTING EDGE OF MACHINING CONTROL

Company Name	Hall	Stall
Agile Machineries Pvt. Ltd	1A	A116
Alex Machine Tools Pvt. Ltd	1A	A108
AMTDC	1A	E104
Arntz Techsaw Pvt. Ltd	1A	F107
B. R. Precisions	1A	A114
Batliboi Ltd	1A	A105
Bharat Fritz Werner Ltd	1A	A102
Brisk Tech Engineers	1A	B115
Broach Technology (India) Pvt. Ltd	1A	B112
Chennai Metco Pvt. Ltd	1A	A101
CNC India Tools & Services Pvt. Ltd	1A	B116
Concord United Products Pvt. Ltd	1A	C101
Eagle Industries	1A	F101
Fenwick and Ravi	1A	A106
Fine Handling & Automation Pvt. Ltd	1A	B120
Forbes & Company Ltd	1A	B109
GH Induction India Pvt. Ltd	1A	B111
Gravotech Engineering Pvt. Ltd	1A	B118
Hi-Life Machine Tools Ltd	1A	B104
IMEXSU Group	1A	C102
IMTMA Technology Centre	1A	B102a
Infion Advanced Laser Systems Pvt. Ltd	1A	A112
ITL Industries Ltd	1A	D101
K Engg. Products	1A	A104
Kennametal India Limited	1A	B103
Khushbu Engineers	1A	B108

Company Name	Hall	Stall
Laxman Kadva & Sons Pvt. Ltd	1A	B113
Manisha Machinery Pvt. Ltd	1A	A103
Mitsubishi Electric India Pvt. Ltd	1A	B107
Multicut Machine Tools	1A	B110
Patel Furnace & Forging Pvt. Ltd	1A	F103
Pinnacle Engineering Enterprise	1A	F102
Pride Machine Tools Pvt. Ltd	1A	E101
Ratnaparkhi Electronics Industries Pvt Ltd	1A	E102
S & T Machine Tools Pvt. Ltd	1A	B114
Sandstorm Equipment Co.	1A	A109
Sharda Mechanic Works Pvt. Ltd	1A	E103
Shenoy Engineering Pvt. Ltd	1A	F105
Solitaire Machine Tools Ltd	1A	A113
Sparkonix (India) Pvt.Ltd	1A	B105
Stamp IT Robotai & Solutions Pvt. Ltd	1A	A111
Sunita Engineering Corporation	1A	B106
Swastik Engineers	1A	A107
Trishul Machine Tools Pvt. Ltd	1A	A110
UCAM Pvt. Ltd	1A	B101
Unique Saws & Machinery Pvt. Ltd	1A	A115
V. V. Engineering Works	1A	A117
Venus Automation Pvt. Ltd	1A	F104
Vision Embesoft Solution	1A	F106
Zeal Tech Automation	1A	B102



**R+W Couplings
HSD Spindles
Rotoflux Rotary Union**



**VISIT US AT
HALL - 1 A, STALL B-101**

Hall 1B

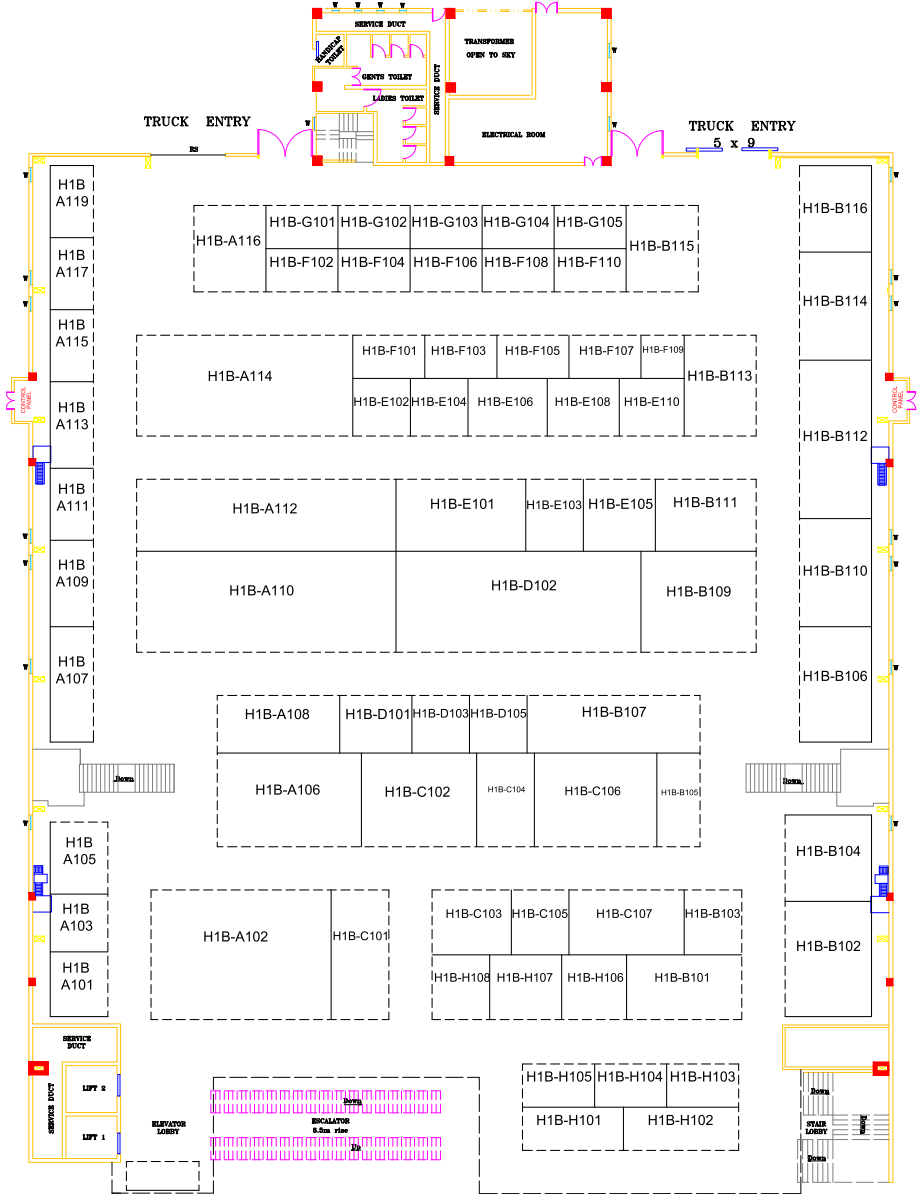

Company Name	Hall	Stall
ACME Manufacturing Company	1B	A103
Allied Machine & Engineering Corp.	1B	B102
AMT - The Association For Manufacturing Technology	1B	C105
AMT Chennai Technology & Service Centre	1B	C107
Autogrip Machinery Co., Ltd	1B	E108
Axisco Precision Machinery Co., Ltd	1B	E110
Balance Systems Srl	1B	H101
C.matic Spa	1B	H104
CG Tech	1B	H106
Chain Headway Machine Tools Co. Ltd	1B	B110
Chengdu Bangpu Cutting Tools Co.,Ltd	1B	A116
Chengdu B-to-O Superhard Materials Co.,Ltd	1B	G102
Chengdu Met-ceramic Advanced Materials Co.,Ltd	1B	B115
Chengdu Minjiang Precision Cutting Tool Co.,Ltd	1B	F106
Chengdu NEWKer CNC-Technology Co.,Ltd	1B	F104
Chengdu Tianhe Tungsten Carbide Tools Co.,Ltd	1B	G103
Chieftek Precision Co., Ltd.	1B	B109
Ching Hung Machinery & Electric Industrial Co., Ltd.	1B	A112
Chum Power Machinery Corporation	1B	F101
CP Grat - Ex Manufacturing Company	1B	B116
Dongguan Baotn Machinery Co.Ltd.	1B	F102
Dongguan Xinbang CNC Tools Co.,Ltd	1B	G101
Echaintool Industry Co., Ltd.	1B	A111
Ekin, S. Coop.	1B	B106
Engis Corporation	1B	H107
ESPRIT by DP Technology	1B	B101
Etex-Tar, S.A.	1B	C106
Exact Machinery Co., Ltd	1B	B112
Factory Automation Technology Co., Ltd	1B	A110
Fagor Automation S.L.	1B	A106
Farman Machinery Industry Co., Ltd	1B	A109
Gifu Enterprise Co., Ltd	1B	B111
Gurutze Turning Solutions S.L.	1B	C104
Hardinge Asia Ltd	1B	A102
Hong Ji Precision Machinery Ltd.	1B	F105
Hota Industrial Mfg. Co., Ltd	1B	E101
HPB Motion Control Co., Ltd	1B	F109

Company Name	Hall	Stall
Ibarmia	1B	D105
ICEX- Spain Trade And Investments	1B	D101
Ilyich Abrasive Company	1B	H105
Italian Technology Centre	1B	A107
ITSAID Corporation	1B	A117
Jagular Industry Ltd	1B	E104
Jarng Yeong Enterprise Co., Ltd	1B	E106
Jergens, Inc.	1B	B103
Jiuh-Yeh Precision Machinery Co., Ltd	1B	E103
Juaristi	1B	A108
Kenturn Nano. Tec. Co., Ltd	1B	B112a
Kyocera SGS Precision Tools, Inc.	1B	A105
Li-Chou Machinery Industry Co., Ltd	1B	E102
Losma Spa	1B	A107
Mastercam - CNC Software, Inc.	1B	C101
Minchuen Electrical Machinery Co., Ltd	1B	B113
Naxau new materials corporation	1B	G105
Nicolas Correa	1B	C102
Omg Srl	1B	H102
Palmary Machinery Co., Ltd	1B	D102
Peiping Precision Enterprise Co., Ltd	1B	F107
Precision Motion Industries, Inc.	1B	A114
Quality Vision International, Inc (QVI)	1B	C103
Rocklin Manufacturing Co.	1B	A101
Sanjay Tools & Adhesives	1B	B104
Seedtec Machinery Co., Ltd	1B	F103
Shuton, S.A.	1B	D103
SIT S.p.A	1B	H103
Speed Tiger Precision Tool Co., Ltd	1B	A119
Sunus Tech Co., Ltd	1B	A113
Taicin L. S. Co., Ltd	1B	A115
Taizhou Xi-Tong Tool Co.,Ltd	1B	G104
Talleres Gamor	1B	B105
Tung Pei Industrial Co., Ltd	1B	B114
Vektek, LLC	1B	H108
Yih Troun Enterprise Co., Ltd.	1B	E105
Yiyou CNC Tools (Guang Dong) Co.,Ltd	1B	F110
Zayer	1B	B107
Zigong Xili CNC Tool Co.,Ltd	1B	F108



Mastercam

**WE SHAPE THE FUTURE.
DO YOU HAVE WHAT IT TAKES?**

WWW.MASTERSOF CAM.COM

VISIT US AT BOOTH C101 IN HALL 1B, TO AVAIL SPECIAL OFFERS!

Hall 2A

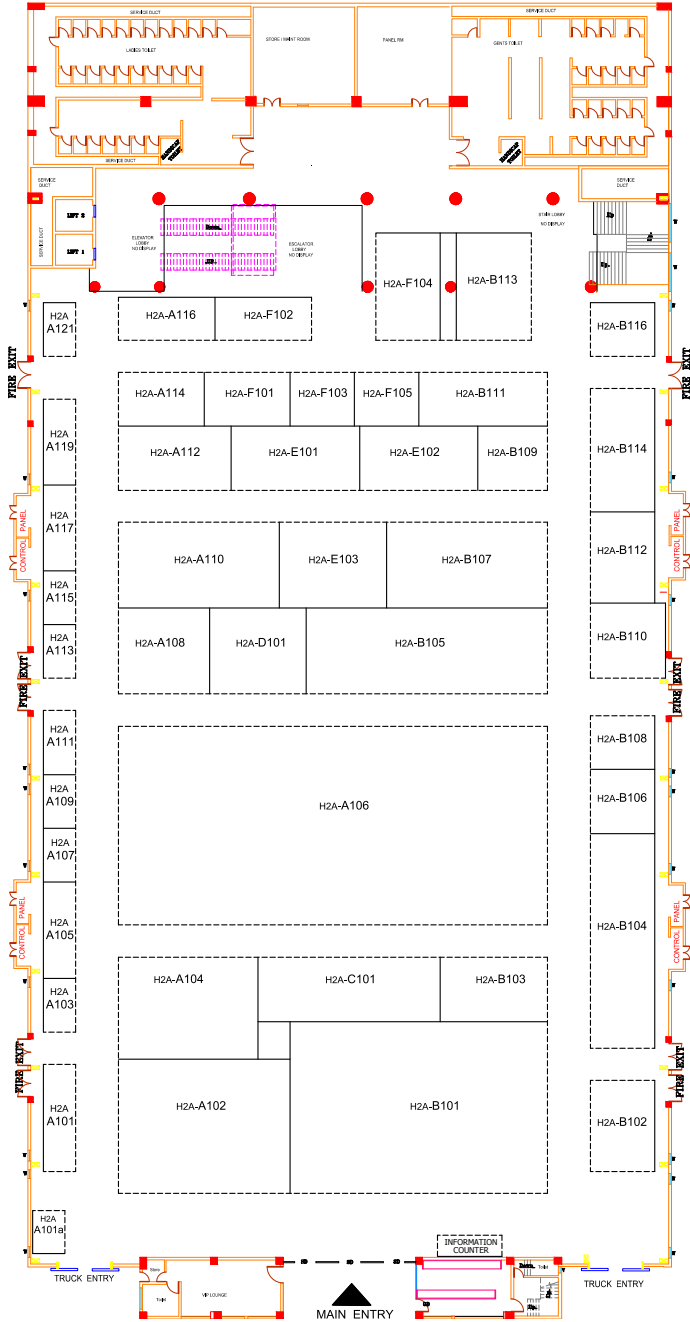

Company Name	Hall	Stall
Abhi Fine Products	2A	A101
Abhijat Equipments Pvt. Ltd	2A	F101
Acumac Machine Tools Pvt. Ltd	2A	B113
ARK Machtek Pvt. Ltd	2A	C101
Arrow Machine Tools	2A	E101
Askar Microns Pvt. Ltd	2A	B105
Benco Thermal Technologies Pvt. Ltd	2A	B108
Ceramed Engineers Ltd	2A	A115
Control Technics	2A	A109
Creative Engineering	2A	B103
Dalal Engineering Pvt. Ltd	2A	B109
East Coast Magnets Pvt. Ltd	2A	A112
EFD Induction Pvt. Ltd	2A	B111
Electronica India Ltd	2A	B107
Endo Kogyo India Pvt. Ltd	2A	F105
Felsomat India Pvt. Ltd	2A	B104
Gala Precision Engineering Pvt. Ltd	2A	A114
Gedee Weiler Pvt. Ltd	2A	A104
Gudel India Pvt. Ltd	2A	A110
Hytech Machine Tool & Automation India Pvt. Ltd	2A	F103
Indotech Industries (I) Pvt. Ltd	2A	E103
Inductotherm (India) Pvt. Ltd	2A	B102
Lapmaster Wolters India Pvt. Ltd	2A	B116

Company Name	Hall	Stall
Malwa Machine Tools (India) Pvt. Ltd	2A	A107
Mehta Cad Cam Systems Pvt. Ltd	2A	A111
Microtech Machines	2A	A103
Microtek Grinding Machines Pvt. Ltd	2A	A119
Precision Machinekraft Pvt. Ltd	2A	F104
PSG Industrial Institute	2A	E102
Ravisons Corporation	2A	A121
S & T Group	2A	A106
Sahajanand Laser Technology Ltd	2A	A108
Sajraj Technologies	2A	A113
Seventh International	2A	A116
Speedfam (India) Pvt. Ltd	2A	B110
Spinks Impex	2A	B106
Strategi Automation Solutions Pvt. Ltd	2A	A117
Suntech Landriani Machine Tools Pvt. Ltd	2A	B112
TAL Manufacturing Solutions Ltd	2A	B114
Tool Grinding Technologies Inc.	2A	D101
Toolcraft Systems Pvt. Ltd	2A	A105
Tsugami Precision Engineering India Pvt. Ltd	2A	B101
Tumakuru Machine Tool Park (TMTP)	2A	A101a
Vigel Manufacturing Technologies Pvt. Ltd	2A	A102
Wave Tools & Technologies	2A	F102

work in

flowmotion

GÜDEL

Visit our booth at
Hall No. 2A, Stall No. A110

in.gudel.com

Hall 2B

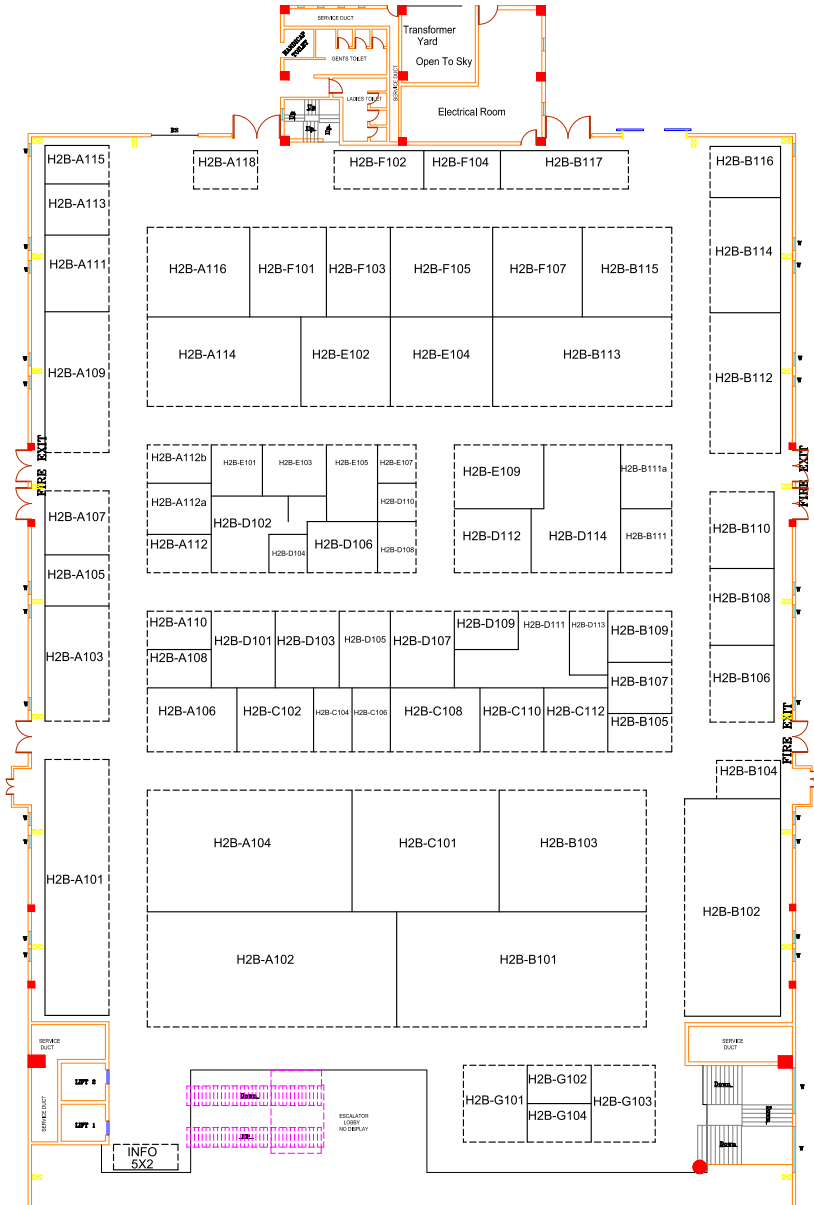

Company Name	Hall	Stall
Allmatic-Jakob Spannsysteme GmbH	2B	B106
Andreas Maier Workholding Technology Pvt.Ltd	2B	B112
Apm Technologies	2B	F105
Arno Friedrichs Hartmetall GmbH & Co.KG	2B	D106
August Rugeberg GmbH & Co. Kg - PFERD-Tools	2B	B110
Avantec GmbH	2B	C104
Baden-Württemberg International	2B	D111
Balluff GmbH	2B	A114
Bayern International - Bavarian	2B	D102
Benz GmbH Werkzeugsysteme	2B	C110
Bielomatik Leuze GmbH + Co. KG	2B	C106
Botek Präzisionsbohrtechnik GmbH	2B	D103
BURKHARDT+WEBER Fertigungssysteme GmbH	2B	G102
C. & E. Fein GmbH	2B	B109
Carl Zeiss India (Bangalore) Pvt. Ltd	2B	A102
Cemecon AG	2B	B116
CPT GmbH	2B	F103
DIATOOL Präzisionswerkzeuge GmbH	2B	A110
EMAG GmbH & Co. KG	2B	A104
Eppinger Tooling Asia Pvt. Ltd	2B	B114
Erwin Junker Maschinenfabrik GmbH	2B	B113
EUCHNER GmbH + Co. KG	2B	D107
Exeron GmbH	2B	D109
Felss Group GmbH	2B	A105
Festo India Private Limited	2B	A101
FlexiCam GmbH	2B	D104
Fluid Logic Systems Pvt. Ltd	2B	B115
Frankfurt Rhein Main GmbH	2B	D114
Gehring Technologies GmbH	2B	C108
GMN Paul Muller Industrie GmbH & Co. Kg	2B	E105
Guenther Effgen GmbH	2B	B108
Hessen Trade & Invest GmbH	2B	D114
Hydac India Pvt. Ltd	2B	E102
Ifm Electronic India Pvt. Ltd	2B	A116
Index-Werke GmbH & Co. Kg	2B	C102
Indo-German Chamber of Commerce (IGCC)	2B	
Inovatools Eckerle & Ertel GmbH	2B	A112
Jenoptik India Pvt. Ltd	2B	A109
Jokari-Krampe GmbH	2B	B104

Company Name	Hall	Stall
Kapp GmbH & Co. KG	2B	G103
Kasto Maschinenbau GmbH & Co. KG	2B	A115
Kelch GmbH	2B	C112
KNIPEX-Werk C. Gustav Putsch KG	2B	F104
Konig-mtm GmbH, Spanntechnik	2B	B107
Krebs & Riedel Schleifscheibenfabrik GmbH & Co.Kg	2B	B111a
Leitritz Produktionstechnik GmbH	2B	D110
LUKAS-ERZETT Vereinigte Schleif- und Fraswerkzeugfabriken GmbH & Co. KG	2B	F102
Machine House (India) Pvt. Ltd	2B	A111
Mahr Metrology India Pvt. Ltd	2B	F101
Mapal India Pvt. Ltd	2B	B103
Maschinenfabrik Alfing Kessler GMBH	2B	A108
Mayr power transmission/Chr. Mayr GmbH+Co. KG	2B	A112a
MEBA Metall- Bandsägemaschinen GmbH	2B	D105
Mimatic GmbH	2B	A112b
NGCT Cleansys Pvt. Ltd	2B	G101
Open Mind Technologies AG	2B	E103
Oriental Engineering Works Pvt. Ltd	2B	G104
Osborn International GmbH	2B	E109
OTT- Jakob Spanntechnik GmbH	2B	E101
Paul Horn GmbH	2B	A106
Phoenix Contact (I) Pvt. Ltd	2B	B102
Pro-Micron GmbH	2B	E107
Schwewler Werkzeugfabrik GmbH & Co. KG	2B	D108
Siemens Ltd	2B	B101
SMS Maschinenbau GmbH	2B	B105
Stroh Diamantwerkzeuge GmbH	2B	B111
Suave Engineering	2B	A113
Teknic Euchner Electronics Pvt. Ltd	2B	C101
TMC Measuring Instruments Pvt. Ltd	2B	E104
Vollmer Technologies India Pvt. Ltd	2B	F107
VSM Vereinigte Schmirgel- und Maschinen-Fabriken AG	2B	A107
Weidmuller Electronics India Pvt. Ltd	2B	A118
Weiler Abrasives GmbH	2B	B117
Wikus-Saegenfabrik GmbH & Co. KG	2B	D112
Zecha Hartmetall-Werkzeugfabrikation GmbH	2B	D101
Zimmer Automation LLP	2B	A103
Zollern GmbH & Co. KG	2B	D113



CLAMPING. SCREWING. LOCKING.

World leader in clamping...

Quality Since 1890



ANDREAS MAIER WORKHOLDING TECH. PVT. LTD.

(Subsidiary of : AMF - GERMANY)

www.amf.de

Visit us at:
Hall No. 2B, Stall No. B112



Hall 3A

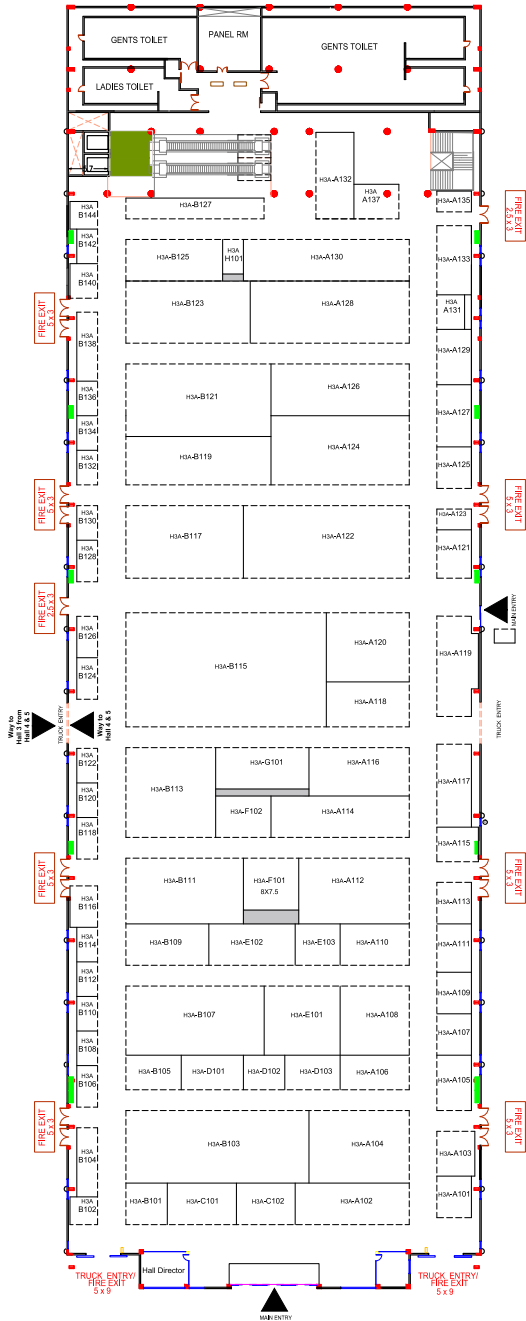

Exhibitors' List - Hall 3A

Company Name	Hall	Stall
Accurate Gauging & Instruments Pvt. Ltd	3A	B113
Accusharp Cutting Tools Pvt. Ltd	3A	F101
Biltz Cutting Tools Company	3A	A137
Birla Precision Technologies Ltd	3A	B116
Blaser Swisslube India Pvt. Ltd	3A	A118
CAD Macro Design and Solutions Pvt. Ltd	3A	B120
Cleantek	3A	B112
Dijet Industrial Co., Ltd	3A	C102
Dormer Tools India Pvt Ltd	3A	B119
Dynemach Systems Pvt. Ltd	3A	B144
Elesa And Ganter India Pvt. Ltd	3A	A115
Emkay Tools	3A	A132
Falcon Toolings	3A	A109
Faro Business Technologies India Pvt. Ltd	3A	B104
Globus Engineering Tools	3A	H101
Guhring India Pvt. Ltd	3A	A122
Haimer India Pvt. Ltd	3A	A104
Heidenhain Optics & Electronics India Pvt. Ltd	3A	G101
Hexagon India Pvt. Ltd	3A	A112
Igus India Pvt. Ltd	3A	A117
Indo Nihon Technologies	3A	A114
Ind-Sphinx Precision Ltd UNIT B	3A	A106
Innovation Filter System Pvt Ltd	3A	A131
Iscar India Ltd	3A	B117
Jai Balaji Control Gears Pvt. Ltd	3A	F102
K. C. Precision	3A	B101
Kabelschlepp India Pvt. Ltd	3A	A107
Kapsun Resources Corporation	3A	B106
KJK MeisterHonen Pvt. Ltd	3A	A105
Komet / Ceratizit Group	3A	B115
Korloy India Tooling Pvt. Ltd	3A	A126
Kristeel Shinwa Industries Ltd	3A	A135
Kudale Instruments Pvt. Ltd	3A	B142
Kyocera CTC Precision Tools Pvt. Ltd	3A	A119
Lex Technoaid Intenational Pvt. Ltd	3A	A111
LMT Tools India Pvt. Ltd	3A	A120
Luthra Pneumsys	3A	B140
Marposs India Pvt. Ltd	3A	B111
Mitutoyo South Asia Pvt. Ltd	3A	B107
M'La Sales Corporation	3A	A127
MMC Hardmetal India Pvt. Ltd	3A	A124

Company Name	Hall	Stall
MST Corporation	3A	A130
Nickunj Eximp Entp. P. Ltd	3A	A116
Octagon Precision (India) Pvt. Ltd	3A	A110
Oerlikon Balzers Coating India Pvt. Ltd	3A	E102
Oilmax Systems Pvt. Ltd	3A	B108
Orcan Products of India	3A	B134
OSG (India) Pvt. Ltd	3A	C101
Otto Bilz (India) Pvt. Ltd	3A	A133
Pace India	3A	B124
Perfect Magnets	3A	B110
Polyworks Software India Pvt. Ltd	3A	A101
Pratap Tex Chem Pvt. Ltd	3A	A103
Quaker Chemical India Private Limited	3A	B105
Ramm Precision Products Pvt. Ltd	3A	B122
Renishaw Metrology Systems Ltd	3A	B103
Riya Electrodes Pvt. Ltd	3A	A113
Setco Spindles India Pvt. Ltd	3A	D102
Sharp Industries	3A	B130
SMW Autoblok Work Holding Pvt. Ltd	3A	B109
Sovereign Syndicate	3A	B132
Sovereign Tech Engineering Services Pvt. Ltd	3A	A102
SP Leak Test and Automation Pvt Ltd	3A	B114
State Engineering Corporation	3A	A129
Strub India Pvt. Ltd	3A	B102
Surhennig Pvt. Ltd	3A	A108
Sylvac SA	3A	B127
TaeguTec India Pvt. Ltd	3A	A128
Tech Mech Handling Equipment	3A	A121
Tosei Engineering Pvt. Ltd	3A	D103
Transtech Gears Pvt. Ltd	3A	B138
Tsudakoma Corp.	3A	E103
Tungaloy India Pvt. Ltd	3A	B123
Turnmax Machine Tools	3A	B128
Universal Abrasives	3A	B126
Universal Engineering & Manufacturing Industry	3A	D101
U-Tech Associates	3A	E101
Veekay Industries	3A	B136
WTO GmbH	3A	A125
YG Cutting Tools Corporation Pvt. Ltd	3A	B121
YH Tools Manufacturers	3A	B118
Zavenir Daubert India Private Limited	3A	B125

**Reach Buyers
Not Bots**



**MODERN
MANUFACTURING
INDIA**

WWW.MMIINDIA.CO.IN

The Official Magazine of
 IMI
 Indian Machine Tool
 Manufacturers' Association
 In Association with
 Modern
 Machine
 Shop

Hall 3B

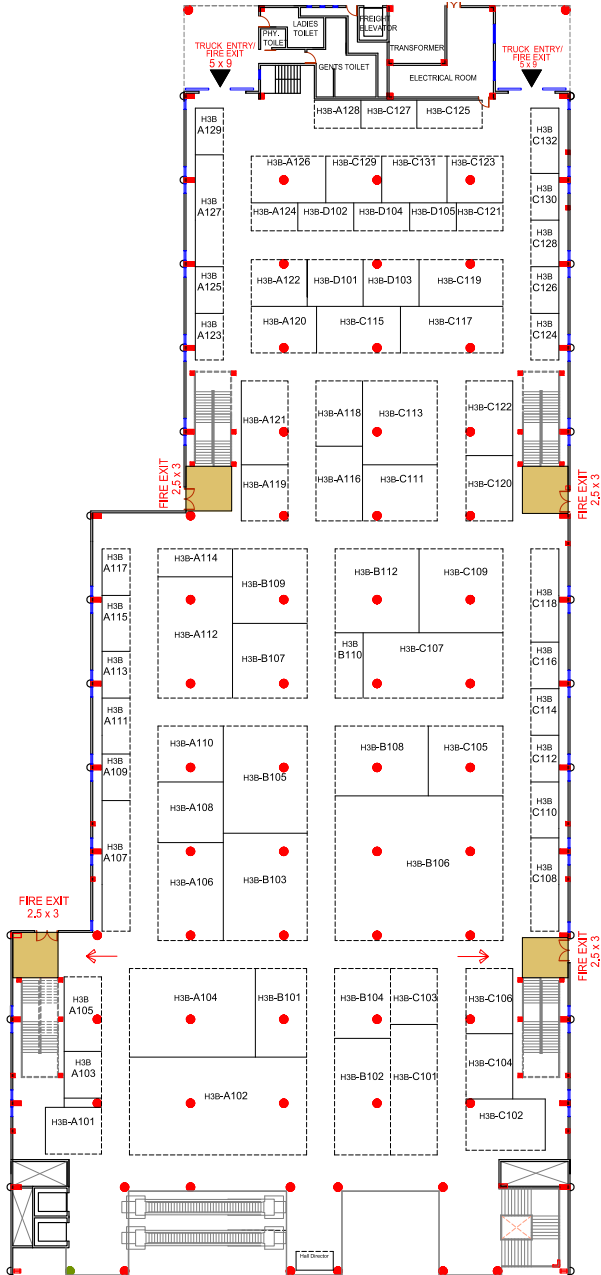

● Pillar Size: 1m x 1m

Company Name	Hall	Stall
Ametek Instruments India Pvt. Ltd	3B	C106
Apar Industries Limited	3B	A123
Atlantic Lubricants & Specialities Pvt. Ltd	3B	C105
ATQ Metro	3B	A129
Axis Engineering Solutions	3B	C119
Baker Gauges India Pvt. Ltd	3B	B105
Branson Ultrasonics	3B	D104
Canares Engineering Co	3B	C121
Capital Engineering Corporation	3B	C110
Carbtools (India) Pvt. Ltd	3B	A121
Carl Bechem Lubricants (India) Pvt. Ltd	3B	A105
Carmet Tools & Inserts	3B	B104
Carmex Precision Tools Ltd	3B	A126
Carr Lane Manufacturing Co.	3B	D101
Chemetall India Pvt. Ltd	3B	C108
Control And Framing Systems	3B	A127
Customised Technologies Pvt. Ltd	3B	C111
Darshana Industries Pvt. Ltd	3B	A104
Diamond Abrasive Products	3B	A117
Dynascan Inspection Systems Company	3B	C103
Emmppe Associates	3B	C130
Ferro Foundries Pvt. Ltd	3B	C131
Finetech Toolings	3B	A125
Future Technologies	3B	A114
Geo Informatics Consultants Pvt. Ltd	3B	C126
Givi Misure Pvt. Ltd	3B	A122
GOSTOL TST India Pvt.Ltd	3B	C132
Green Automation System	3B	C127
Hartner GmbH	3B	B101
HMB International - Gesac	3B	C109
Hoffmann Quality Tools India Pvt. Ltd	3B	A112
Humifogg Systems	3B	D102
IMI Machine Tools Pvt. Ltd	3B	A120
IMPEX World	3B	D105
Innovative Automation Products	3B	B112
Insize India	3B	A111
Janatics India Pvt. Ltd	3B	B109
Jash Precision Tools Ltd	3B	C113
Kitagawa India Pvt. Ltd	3B	A106

Company Name	Hall	Stall
Kosmek Ltd	3B	C102
Linear Ways India	3B	A109
Lube Automatic Systems Pvt. Ltd	3B	C112
Machine Elements	3B	B110
Mechengg Industries	3B	C116
Metalcam Technologies Pvt. Ltd	3B	A128
Mikronix Gauges Pvt. Ltd	3B	A108
Millenia Technologies	3B	C120
Miven Mayfran Conveyors Pvt. Ltd	3B	B103
OM Manufacturers	3B	C114
Patel Brass Turnomatics Pvt. Ltd	3B	C124
Rajamane Industries Pvt. Ltd	3B	B107
Rapid Coat Division	3B	C118
Reliance Calibration Laboratory	3B	A115
Robin Precision Products Pvt. Ltd	3B	C122
Rollon India Pvt. Ltd	3B	C104
S. S. Tools India Pvt. Ltd	3B	D103
Samchully Machinery Co., Ltd	3B	B108
Samtec Tools & Accessories Pvt. Ltd	3B	C115
Sandvik Asia Pvt. Ltd	3B	A102
Schmersal India Pvt. Ltd	3B	A118
Schneeberger India Pvt. Ltd	3B	C117
Sipcon Instrument Industries	3B	A101
SRS Technologies	3B	C128
Swift Industrial Corporation	3B	C125
Tectyl Oil and Chemical (India) Pvt. Ltd	3B	C123
Tenryu Saw India Pvt. Ltd	3B	A103
The M. K. Morse Company	3B	C129
THK India Pvt Ltd	3B	B106
Tyrolit India Superabrasive Tools Pvt. Ltd	3B	A116
Unique Industries (India)	3B	A124
Uptech Engineering	3B	A107
V. P. Industries	3B	A110
Vargus Ltd	3B	B102
Vijayshree Wear Parts Pvt. Ltd	3B	A113
VT Tools Pvt. Ltd	3B	A119
Xceed Toolings Pvt. Ltd	3B	C101
Zoller Singapore Pte. Ltd	3B	C107

Who did you notice more?



For Advertising Contact:
Murali Sundaram: +91 9740048390
murali.sundaram@mmindia.co.in



Hall 3C



Company Name	Hall	Stall
A. R. Traders CNC	3C	C101
Addlife Coating Systems Pvt. Ltd	3C	D102
Alok International Pvt. Ltd	3C	A112
AMT - The Association For Manufacturing Technology	3C	E101
Arno & Prompt Toolings India Pvt Ltd	3C	B104
Asapp Info Global Group / Equipment India	3C	D110
Association of Engineering Technology (SST)	3C	E109
Beijing Ribbon International Exhibition Co., Ltd	3C	E111
Bemco Fluidtechnik LLP	3C	A101
Bruker Singapore Pte Ltd	3C	A110
Carbotec India Pvt. Ltd	3C	B102
CCPIT Machinery Sub-Council (CCPIT MSC)	3C	E121
Cenergy Offshore Private Limited	3C	C118
Changzhou Muladili Precision Cutting Tool Co., Ltd	3C	D122
Changzhou Xute Jifeng Tools Group Co.,Ltd	3C	D118
China Machine Tool & Tool Builders Association (CMTBA)	3C	E102
CKS Cable Solutions Pvt. Ltd	3C	C112
Confederation of Indian Industry (CII)	3C	E115
Dee-Kay Clutches Pvt. Ltd.	3C	C111
Dongguan Chengda Machinery Technology Co.,Ltd	3C	D116
Dongguan Guoyi Precision Machinery Co.,Ltd	3C	D104
Dongguan Haojian Hardware Co., Ltd	3C	D105
Dongguan Yafeng Hardware Machinery Co., Ltd	3C	D104a
Elektromag Methods	3C	A116
Eriez Magnetics India Pvt. Ltd	3C	C114
European Committee For Cooperation of the Machine Tool Industries (CECIMO)	3C	E103
Galaxy Chains Pvt. Ltd	3C	C105
German Machine Tool Builders Association (VDW)	3C	E108
Gindumac India Pvt. Ltd	3C	C106
Gogate Electrosystems (N) Pvt. Ltd	3C	D111
Goodnews Measurement Cooperation Pvt. Ltd	3C	C107
Govt. of Karnataka	3C	E119
Guangdong Dagong Robot Co., Ltd	3C	D106
Guangdong Harvest Star Technology Co., Ltd	3C	D106a
Guangdong Zhenshuo CNC Tools Co., Ltd	3C	B101
Hardcastle Petrofer Pvt. Ltd	3C	C104
Hegde Precision Engg Works	3C	A109
Hindustan Abrasive Technology	3C	C115
Iec Air Tools Pvt. Ltd	3C	A103
Japan Machine Tool Builders' Association (JMTBA)	3C	E104
Karcher Cleaning Systems Private Limited	3C	A114
Kendo By Forbes	3C	A104
Korea Machine Tool Manufacturers Association (KOMMA)	3C	E116

Company Name	Hall	Stall
M.S. Tools & Manufacturing Company Pvt. Ltd	3C	D101
Machinomatic Engineers	3C	B106
Marvel Abrasive Tools	3C	C122
N.Gandhi & Co.	3C	A113
National Institute of Design (NID)	3C	E113
New Generation Tools	3C	D114
Nitto Kohki Co., Ltd	3C	C119
Pneumec Kontrols Pvt Ltd	3C	D107
Prime Precisions Pvt. Ltd	3C	B107
Reliance Engineering Company	3C	A111
Riddhim Siddhim Steel India Pvt. Ltd	3C	C109
Rishabh Power Components	3C	D112
Rokade Rotek India Pvt. Ltd	3C	C113
Rontgen Saws Pvt. Ltd	3C	D115
Rotodyne Fluid Technic	3C	C110
Sanpar Microfilters Pvt. Ltd	3C	D113
Saveawatt Power Electronics Pvt. Ltd	3C	C103
Shining Tools Ltd	3C	A106
Shobha Industries Pvt. Ltd	3C	A108
Sigma Engineers	3C	C102
Sivenara Engineers	3C	D103
Society for Innovation and Development Innovation Centre (SID) / Indian Institute of Science (IISC)	3C	E120
Stanley Black & Decker India Pvt. Ltd	3C	B103
Stellar Engineering	3C	B105
Sundaram Finance Ltd	3C	D109
Swift Industrial Agencies	3C	C117
System Controls Technology Solutions Pvt. Ltd	3C	A102
Taiwan Association of Machinery Industry (TAMI)	3C	E110
Teksal Systems	3C	C116
The All India Plastics Manufacturer's Association (AIPMA)	3C	E122
The Manufacturing Technologies Association (MTA)	3C	E105
The Mexican Association of Machinery Distributors (AMDM)	3C	E106
The New Ball Bearing Co.	3C	B108
Tool and Gauge Manufacturers Association (TAGMA)	3C	E114
Tribotech	3C	C120
UBteck Carbide	3C	C108
Ucimu-Sistemi Per Produrre (UCIMU)	3C	E107
Voestalpine High Performance Metals India Pvt. Ltd	3C	A105
Widin Co., Ltd	3C	A107
Wood Craft	3C	D108
Zhejiang Ivke Machinery Technology Co., Ltd	3C	D120

Hall 4

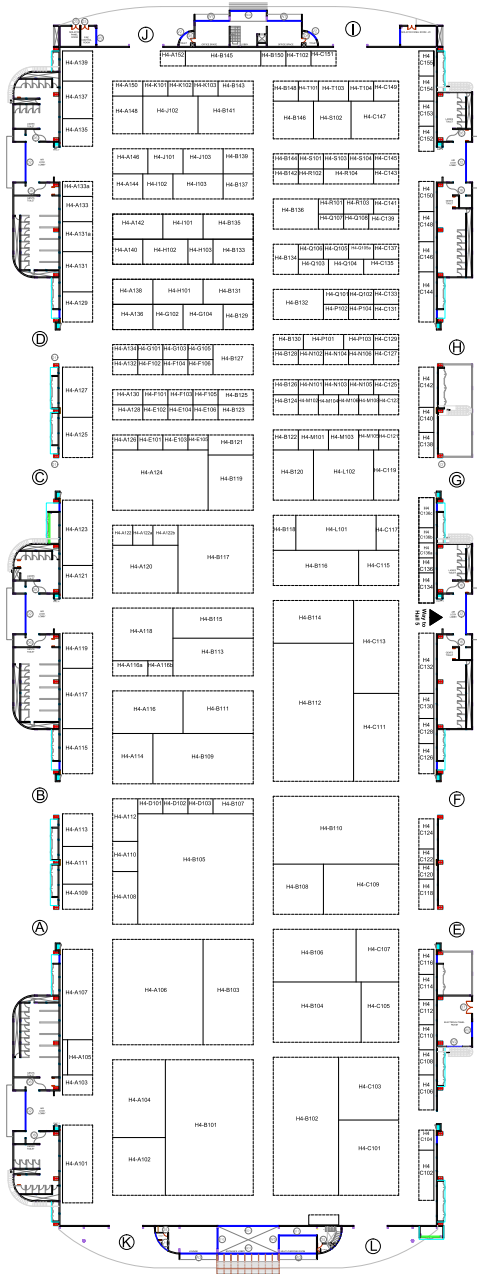

MAIN ENTRY

Company Name	Hall	Stall
Abro Technologies Pvt. Ltd	4	A117
Accu-fix Precision Tools Pvt. Ltd	4	B137
Advanced Machine Tool Testing Facility (AMTTF)	4	C104
Alkon Plastics Pvt. Ltd	4	B144
Anca Pty Ltd	4	C109
Anhui Huaxia Machine Manufacturing Co., Ltd	4	B128
Apex Precision Mechatronix Pvt. Ltd	4	A137
Apsom Infotex Ltd	4	D103
A-Ryung Machinery Ind.Co., Ltd	4	C132
Avi Oilless Die Components India Pvt. Ltd	4	B148
Beijing Worldia Diamond Tools Co. Ltd	4	B126
Benxi Tool Co.,Ltd	4	C131
Blum-Novotest Measuring And Testing Technology Pvt. Ltd	4	C147
Bowers Group	4	A122a
Breton SpA	4	A121
Brother International India Pvt. Ltd	4	A102
C. P. Agencies	4	L101
Changzhou City Wansui Tools Works	4	A132
Changzhou Guangxin Tools Co.,Ltd	4	P101
Chiron-Werke Gmbh & Co. Kg	4	A108
CHN-Top Sci & Tech Co.,Ltd	4	C118
Chrstec Machine Tools Pvt. Ltd	4	A123
Cimtrix Systems Pvt. Ltd	4	G104
CKD Corporation	4	A146
Clasys	4	J103
Conprofe Technology Group Co.,Ltd	4	N101
CY Carbide Mfg. Co., Ltd	4	M101
Daegu Gyeongbuk Machinery Cooperative(DGMC)	4	B145
Dalian Accut Machinery Co., Ltd	4	B125
Delta Electronics India Pvt. Ltd	4	B141
Designtech Systems Ltd	4	C150
DJTOL Grinding Machine Group CO.,LTD	4	N106
DMG MORI India Pvt. Ltd	4	B101
Dong San Ind Co., Ltd.	4	C122

Company Name	Hall	Stall
Dongguan Qiandao Machinery Manufacturer Co., Ltd	4	F105
Doosan Machine Tools Co., Ltd	4	B102
Durga Bearings Company Pvt Ltd	4	S102
Dutch Tech Tools Pvt. Ltd	4	B135
DVS Technology Group	4	A107
Dyc Co.,Ltd	4	C136a
Dynavac India Pvt. Limited	4	S101
Eclipse Magnetics Ltd	4	A122
Ecoclean Machines Pvt. Ltd	4	B131
Emdeetec	4	H103
Empire Machine Tools (MCAT Division)	4	B106
Epson India Pvt. Ltd	4	C117
Erowa S.E.A Pte. Ltd	4	C142
EST Tools Co.,Ltd	4	G101
Fermat Group, A.S.	4	B108
FFG MAG INDIA	4	B112
Fibro India Precision Products Pvt. Ltd	4	B146
Filtek India Pvt. Ltd	4	T102
Filtermist International Ltd	4	A122b
Fine Spavy Associates & Engineers Pvt. Ltd	4	J102
Formosa Machinery & Equipment Pvt. Ltd	4	C119
Francis Klein & Co. Pvt. Ltd	4	A106
Geepax	4	C129
General Imsubs Pvt. Ltd	4	R102
GF Machining Solutions Pte Ltd	4	A124
Globalnx Toolings Automation and Robotics Pvt Ltd	4	A116a
GMT Global INC	4	C151
Goodwill Precision Machinery Co., Ltd	4	E104
GROB Machine Tools India Pvt. Ltd	4	A118
GSK CNC Equipment Co., Ltd	4	A131a
Guangdong Juntai Hydraulic Technology Co., Ltd.	4	E106
Guangzhou Haozhi Industrial Co., Ltd	4	B132
Guindy Machine Tools Ltd	4	A148
Hangzhou Zhiguang Saw Industry Co.,Ltd	4	E102

CONTD...



**Please visit us at
Hall No. 4, Booth No. C147**

BLUM
focus on productivity

Blum Novotest Measuring & Testing Technology Pvt. Ltd.

+91 9353025005 | +91 7299086360 | +91 7028004451 | +91 7840008277

www.blum-novotest.com

Hall 4

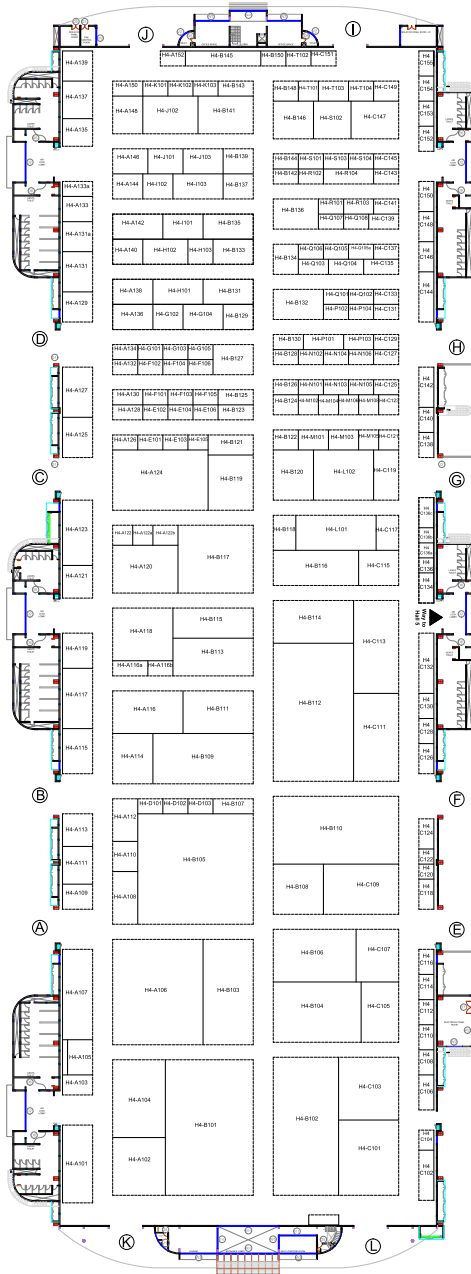

MAIN ENTRY

Company Name	Hall	Stall
Hansung GT Co.,Ltd	4	C124
Hawe Hydraulics Pvt. Ltd	4	A129
Hebei Huayuan Machine Tool Accessories Co., Ltd	4	M108
Heimatec India Pvt. Ltd	4	A140
Heller India Pvt. Ltd	4	B119
Henan Bohong New Material Co.,Ltd	4	Q106
Henninger GmbH & Co.KG	4	C138
Hindustan Export & Import Corporation Pvt. Ltd (HEI)	4	A116
Hiwin Technologies Corp.	4	B110
Holroyd Precision Ltd	4	A116b
Hurco India Pvt. Ltd.	4	C113
Hwacheon Asia Pacific Pte Ltd	4	C103
Ionbond Coatings Pvt. Ltd	4	A139
J. N. Tools	4	C146
Jiangsu Hauto CNC Technology Co.,Ltd	4	C133
Jiangsu Swift Machinery Technology Co.,Ltd	4	F101
Jianye Group Co., Ltd	4	Q101
Jinan Golden Bridge Precision Machinery Co.,Ltd.	4	E103
Jinan Institute of Metallurgical Science Co., Ltd	4	M103
Jinan Sunrise CNC Machine Co.,Ltd	4	N105
Jinan XingTian Sunshine CNC Machine Co., Ltd	4	N104
Jinsheng Trading Dalian Co.,Ltd	4	E101
KGD Co., Ltd.	4	C128
Kistler Instruments India Pvt. Ltd	4	C110
KJF Co.,Ltd.	4	C136c
Klingelberg India Pvt. Ltd	4	A104
Komatsu India Pvt. Ltd	4	B113
KOMMA	4	C136b
Kotec. Co. Ltd	4	C136
KRS Multilub Pvt. Ltd	4	R104
KTA Spindle Toolings	4	A136
Laiyin Measurement Technology (Dong Guan) Co.,Ltd	4	F103

Company Name	Hall	Stall
Lakshmi Electro Controls and Automation	4	C108
Lifeng Precision Tools (Zhejiang) Co.,Ltd	4	F104
Longkou Bluetooth NC Equipment Co., Ltd	4	C121
Losma India Pvt. Ltd	4	H101
Luoyang Hongyuan Bearing Technology Co., Ltd	4	Q103
Machine Tools (India) Ltd	4	B116
Maco Corporation (I) Pvt. Ltd	4	C114
MAG India Industrial Automation Systems Pvt. Ltd	4	B112
Magnus Lubricants Pvt. Ltd	4	B142
Marksman	4	C112
Matrix Machine Tool (Coventry) Ltd	4	B117
Mechatronics Control Equipments India Pvt. Ltd	4	B139
MGM Engineering Corporation	4	C149
Mitsubishi Heavy Industries India Precision Tools Ltd (MHI-IPT)	4	A120
Mitsubishi Heavy Industries Machine Tool Co. Ltd	4	A120
Mollart Engineering Ltd	4	C116
Muvtons Castors Pvt. Ltd	4	B129
Nikon India Pvt. Ltd	4	J101
Ningbo Limon Robot Co.,Ltd	4	G105
Ningyuan Machine Tool Pvt. Ltd	4	A111
Nissin Manufacturing Co.,Ltd	4	C115
OKE Precision Cutting Tools Co.,Ltd	4	C135
Okuma India Pvt. Ltd	4	C111
Pace Assembly Tools	4	T104
Paragon Machinery Co., Ltd	4	A114
PD2I Europe GmbH	4	A152
Perfect Machine Tools Co. Ltd	4	A110
Perform Coat Europe AG	4	B118
Phillips Machine Tools India Pvt. Ltd	4	C101
Pilana Metal S.R.O	4	B150
Pointtech Co.,Ltd	4	C120

CONTD...



The Best Partner for Your Success

for a greener tomorrow



The next generation CNC EBK/MR/MR/CNC Series empowers the manufacturing industry with unlimited possibilities and the capability to create innovative value.

www.MitsubishiElectric.in



Visit us at:
Hall 1A, Stall B107

MITSUBISHI CNC
THE CUTTING EDGE OF MACHINING CONTROL

Hall 4

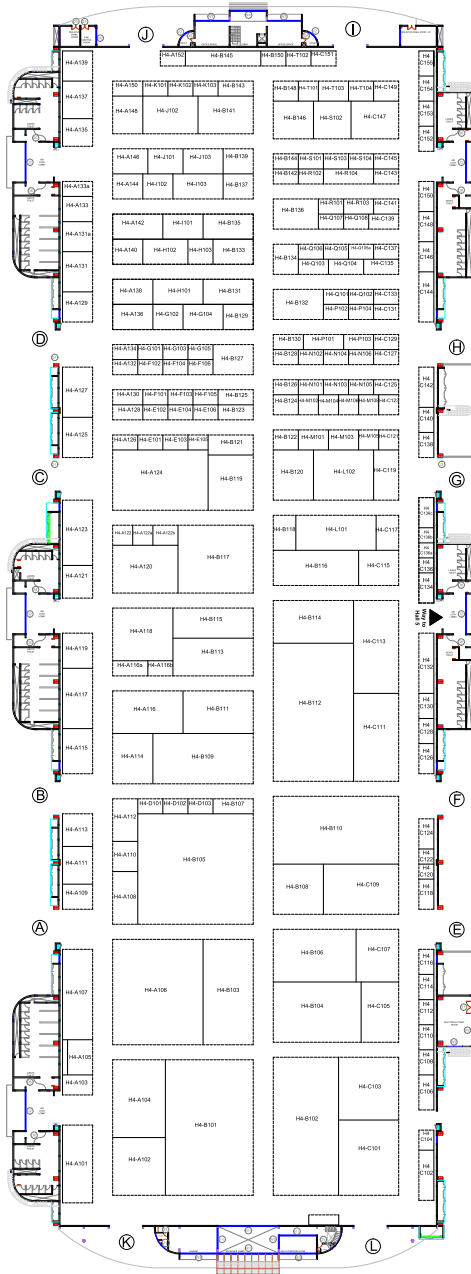

MAIN ENTRY

Company Name	Hall	Stall
Prayasha Enterprise	4	C140
Proteck Machinery Pvt. Ltd	4	B114
Purshotam Company Pvt. Ltd	4	C102
Rajasthan Udyog & Tools Pvt. Ltd	4	S104
Ravik Engineers Pvt. Ltd	4	A119
Real Technologies Machines Pvt. Ltd	4	T103
Rigibore India Pvt. Ltd	4	A138
Rollomatic SA	4	A101
Roop Telsonic Ultrasonix Ltd	4	I102
Rose Plastic India Pvt. Ltd	4	B143
Rudrali Hitech Tools Pvt. Ltd	4	G102
Saacke Machines & Tools Pvt. Ltd	4	A125
Samkrish	4	A142
Samkrish Machine Tools	4	B109
Samputensili Machine Tools	4	B120
Sap Technical & Marketing Consultants	4	B104
SBC Linear co.,Ltd	4	C130
SCT Tools	4	A150
SF Diamond Co., Ltd	4	C125
Shandong Best Precision Co., Ltd	4	G103
Shandong Shanyi CNC Machinery Co.,Ltd	4	M105
Shanghai Esuntek Machinery Co.,Ltd	4	A134
Shanghai Yuhe Diamond Tool Co., Ltd	4	P104
Shanxi Fengyuan Machinery Manufacturing Co., Ltd	4	Q105
Shenzhen William Automation Equipment Co.,Ltd	4	C123
Shin-ii Machinery Co.,Ltd.	4	C134
Shree Manjunath Engineering Precision Tools Pvt. Ltd	4	A131
Sichuan Machinery Imp & Exp. Corp Ltd	4	B134
Sichuan Province Neijiang Qinglongn Machine Tool Co., Ltd	4	Q108
Siddhi Precision Components & Accessories Pvt. Ltd	4	C154
Sino Age Development Technology	4	Q105a
SKB Machine Tools	4	A103

Company Name	Hall	Stall
Sodick Technologies India Pvt. Ltd	4	C107
Span Filtration Systems Pvt. Ltd	4	C145
Speciality Urethanes Pvt. Ltd	4	C143
Spectrum Cutting Solutions Pvt. Ltd	4	K101
Starrag India Pvt. Ltd	4	C105
Steel-Smith	4	A135
Stitch Overseas Pvt. Ltd	4	A115
Suhner India Pvt. Ltd	4	A127
Sunnen India Pvt. Ltd	4	A109
Supply Point Systems Pvt. Ltd	4	C148
Suzhou Haller CNC Grinding Machines Co., Ltd	4	Q104
Swastik Overseas	4	A113
Taguti Industrial Limited	4	E105
Taizhou Beiping Machine Tools Co.,Ltd	4	B123
Taizhou Zhongyu Thread Rolling Tools Co., Ltd	4	R103
Tecnicrafts Industries	4	B133
Tecnologie FRB Srl	4	B127
Termmei Torch & Tip Company	4	A126
Tespa Tools Pvt. Ltd	4	H102
Thielenhaus Technologies GmbH	4	B115
Tisa Enterprises	4	S103
Tooltech Industries	4	C144
Toshiba Machine (Chennai) Pvt. Ltd	4	L102
Trevisan Macchine	4	A112
Trio Motion Technology Ltd	4	B107
Tropicool enovations and Cooling Systems	4	B127
Tschudin AG	4	C106
United Grinding Group Management AG	4	B103
Universal Metrology & Allied Services	4	I101
Usha Fasteners Pvt. Ltd	4	A144
Vijay Gears	4	T101
Viswa Engineering Traders	4	D101
Warrier Electronics	4	K103
Wenling Miaoxin Trading Co.,Ltd	4	N103
Wenzel South Asia Pvt. Ltd	4	C152
Wickman Machine Tools India Pvt. Ltd	4	A105

CONTD...



Torque Motors



VISIT US AT
HALL - 1 A, STALL B-101

HIGH SPEED, HIGH TORQUE
FRAMELESS TORQUE MOTORS

Hall 4

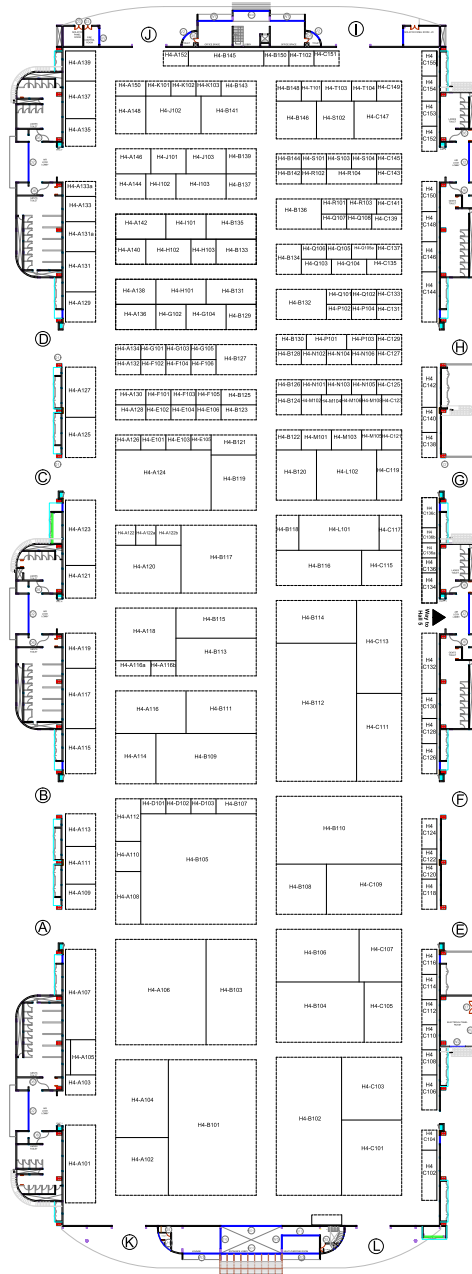

MAIN ENTRY

Company Name	Hall	Stall
Willemijn-Macodel SA	4	D102
Wintegral Engineering Pvt. Ltd	4	K102
Wuxi Zhouxiang International Trade Co Ltd	4	B124
Xinxiang SKF Machinery Co., Ltd	4	M106
Xtreme Gaming Pvt. Ltd	4	C155
Yamazaki Mazak India Pvt. Ltd	4	B105
Yamazen Machinery & Tools India Pvt. Ltd	4	B111
Yangzhou RZF IMP and EXP Co., Ltd	4	M104
Yangzhou Soar Machine Tool Co.,Ltd	4	F102
Yash Machine Tools	4	A133
Yeshwant Industries	4	A133a
YG Tech Co.,Ltd.	4	C126
Young Buhmwoo India Company Pvt. Ltd	4	C153
Yuhuan CNC Machine Tool Co.,Ltd	4	N102
Yuken India Ltd	4	I103
Zhejiang Jinglu Tools Co.,Ltd.	4	B130
Zhejiang San Ou Machinery Ltd. Company	4	A128
Zhejiang Ute Bearing Co.,Ltd	4	F106

Company Name	Hall	Stall
Zhejiang Weilishi Machine Co., Ltd	4	R101
Zhejiang Xinxing Tools Co.,Ltd	4	C127
Zhejiang younio Tools Co.,Ltd	4	P103
Zhengzhou Bertl Hard Materials Co.,Ltd	4	B122
Zhengzhou Diamond Precision Manufacturing Co., Ltd	4	B121
Zhengzhou Zhongnan Jete Superabrasives Co.,Ltd.	4	M102
Zhuzhou Cemented Carbide Cutting Tools Co.,Ltd	4	B136
Zhuzhou Huarui Precision Cutting Tools Co., Ltd	4	C139
Zhuzhou Jinte Cemented Carbide Co., Ltd	4	C141
Zhuzhou Meetyou Cemented Carbide Co., Ltd	4	Q107
Zhuzhou Ruideer Metallurgy Equipments Co., Ltd	4	P102
Zhuzhou Sant Cutting Tools Co.,Ltd	4	A130
Zhuzhou Xinhua Cemented Carbide Industrial Co., Ltd	4	C137
Zigong Haoxin Tool Materials Liability Co., Ltd	4	Q102

When Goals Matter!

M MODERN MANUFACTURING INDIA
WWW.MMINDIA.CO.IN

The Official Magazine of
IMEI
Indian Machine Tool Manufacturers Association
In Association with
Modern Machine Shop

SEARCH FOR THE RIGHT MACHINE

For Advertising Contact: Murali Sundaram: +91 9740048390 • murali.sundaram@mmindia.co.in

Hall 5

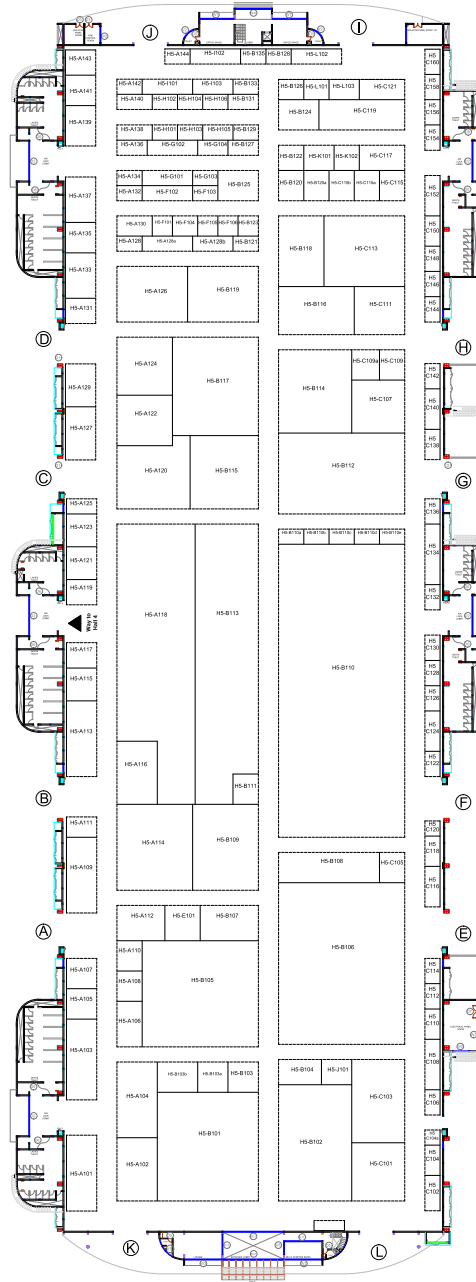

MAIN ENTRY

Company Name	Hall	Stall
Abbott Toolfast Pvt. Ltd	5	B103
Accurate Engineering Company Pvt. Ltd	5	A126
Ace Designers Ltd	5	B113
Ace Manufacturing Systems Ltd	5	A118
AceMicromatic Manufacturing Intelligence Technologies Pvt. Ltd	5	B111
Advance Cooling Systems Pvt. Ltd	5	C152
Air Pel Technic	5	L102
Ambika Trading	5	K102
AMT Group	5	C105
Apex Dynamics (I) JV	5	C140
APT Tools & Machinery India Pvt. Ltd	5	A138
Auram Machines (I) Pvt. Ltd	5	A111
Austin Engineering Company Ltd	5	B127
BBW Brushes Pvt Ltd	5	G103
Bestek Engineering Pvt. Ltd	5	A105
Bhagwansons	5	B110a
Bhagwansons Engineers Pvt Ltd	5	B110b
Bhavi Impex	5	L103
Bhavya Machine Tools	5	B110c
Bombay Tools Supplying Agency (P) Ltd	5	G102
Bosch Rexroth / Indeutsch Systems	5	A128
BPCS Pacific Speciality Petrochemicals Pvt. Ltd	5	H101
Brugarolas India Pvt. Ltd	5	A144
CADEM Technologies Pvt. Ltd	5	F103
Camfil Air Filtration India Pvt. Ltd	5	B128
Carboline Toolings (India) Pvt. Ltd	5	F102
Central Manufacturing Technology Institute (CMTI)	5	A122
CMS SPA	5	B110d
CNC Times Pvt. Ltd	5	C160
Coburg Engineering Services Pvt. Ltd	5	A130
Cosmos Impex (India) Pvt. Ltd	5	B105
Craftsman Automation Pvt. Ltd	5	C111
Crane Bel International Pvt. Ltd	5	C109
Creintors Group	5	G101

Company Name	Hall	Stall
Dahanukar Machine Tools	5	A119
Danobat Grupo Machine Tools India Pvt. Ltd	5	J101
DBZ Technologies	5	C115
Dewan Housing Finance Corporation Ltd (DHFL)	5	A142
Dolphin Exports	5	C114
Donaldson India Filters System Pvt. Ltd	5	A143
Dropco Multilub Systems Pvt. Ltd	5	A131
Drupe Engineering Pvt. Ltd	5	B104
Electronica Hitech Machine Tools Pvt. Ltd	5	B116
Electronica Mechatronic Systems (India) Pvt. Ltd	5	A139
ETA Technology Pvt. Ltd	5	A109
ExxonMobil Lubricants Pvt. Ltd	5	C119
FANUC India Pvt. Ltd	5	B112
Fluro Engineering Pvt. Ltd	5	A106
Fuel Instruments & Engineers Pvt. Ltd (FIE)	5	C113
Galaxy Machinery Pvt. Ltd	5	B119
Geeta Machine Tools Pvt. Ltd	5	A104
Gemini Power Hydraulics Pvt. Ltd	5	C154
GI India Automation And Systems Pvt. Ltd	5	A134
Gishnu Gears	5	C115a
Gleason Works (India) Pvt. Ltd	5	A124
Gole Precision Tools Pvt. Ltd	5	B123
Grind Master Machines Pvt. Ltd	5	A101
Gujarat Lathe Manufacturing Co. Pvt. Ltd	5	E101
HMT Machine Tools Ltd	5	B114
Honsberg Saws India Pvt. Ltd	5	A117
Impression Systems and Engineers Pvt. Ltd	5	I103
IMTMA Technology Centre	5	C104a
Intelmac Machine Tools Pvt. Ltd	5	A120
IPG Photonics (India) Pvt. Ltd	5	A128b
J. K. Machines	5	A110
J. N. Eberle & Cie. GmbH	5	B126
Jagdeep Foundry (Regd.)	5	C122
Jain Diamond Tools / Gaurav Engineers	5	I101
Jain Precision Tools	5	C138

CONTD..



RPM isn't just revolutions per minute. It's also Rupees per minute.

Visit us at Hall 5, Stall No.: C119

Mobil™

ExxonMobil Lubricants Private Limited
Bengaluru - 560048, India
Toll-free no. 000-800100-8401 | indialubeline@exxonmobil.com

IMTEX 2019
Jan 24th - 30th 2019

© 2019 ExxonMobil. All trademarks used herein are trademarks or registered trademarks of Exxon Mobil Corporation or one of its subsidiaries.

Hall 5

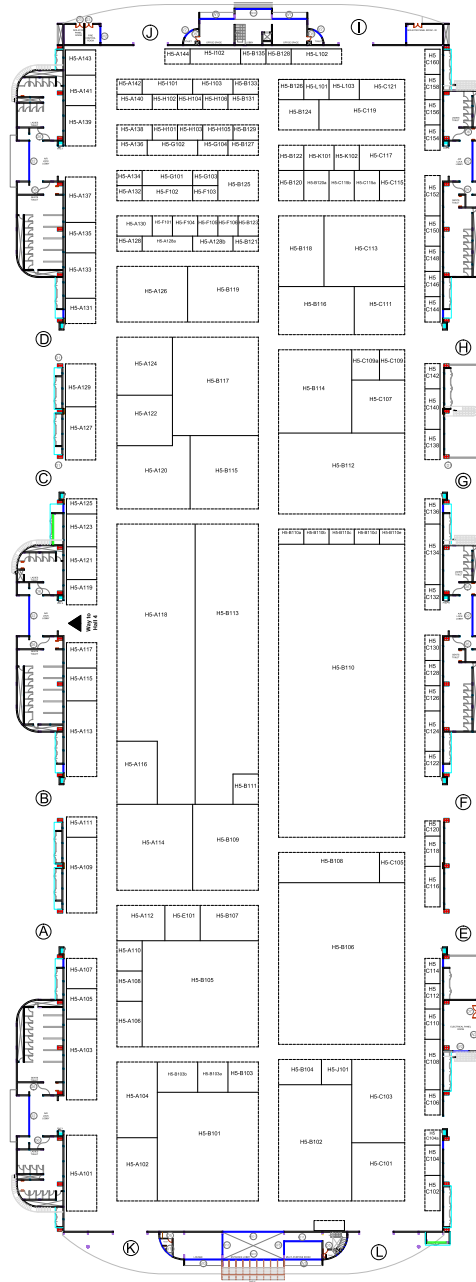

MAIN ENTRY

Company Name	Hall	Stall
Jinagoudra Machine Tools Pvt. Ltd	5	C104
Jyoti CNC Automation Ltd	5	B110
Kentree Enterprises Pvt. Ltd	5	C142
Keyence India Pvt. Ltd	5	C121
Krishna Engineering Works	5	C116
Krishna International	5	H104
KTK Machines (India) Pvt. Ltd	5	A107
Kumbhojkar Plastic Moulders	5	C148
Lakshmi Machine Works Ltd	5	B106
Laservall Technosolutions Pvt. Ltd	5	C110
LNS Asia SA, Taiwan Branch	5	A137
Lokesh Machines Ltd	5	B102
Lubi Industries LLP	5	B120
Machine Tools World	5	H103
Makino India Pvt. Ltd	5	B101
Manar Tools Pvt. Ltd	5	A133
Marshall Machines Limited	5	B115
Max Industries	5	F101
Meera Casting	5	H102
Meiban Engineering Technologies Pvt. Ltd	5	C101
MIC Machine Tools Industries	5	A108
Micro Tooling Systems India Pvt. Ltd	5	C115b
Micromatic Grinding Technologies Ltd	5	A114
Micromatic Machine Tools Pvt. Ltd	5	A116
Mikro Innotech India Pvt. Ltd	5	C106
Mohanlal Ghanshamdas	5	C156
MTE Industries Pvt. Ltd	5	B103a
Narex Zdanice Spol. SRO	5	L101
Neelkanth Power Solutions	5	F104
NRB Industrial Bearings Ltd	5	A135
Omkar Supranational Pvt. Ltd	5	C150
Osaka Seimitsu Kikai Co., Ltd	5	B129
Pi-Tech Services	5	C158
PMT Machines Ltd	5	A103
Pragati Automation Pvt. Ltd	5	B109
Prakash Engitech Pvt. Ltd	5	C102
Prash Machines	5	C128
Precihole Machine Tools Pvt. Ltd	5	C103
Precise Engineers	5	F106
Precision Machine Tool	5	C112
Precision Products Marketing Pvt. Ltd	5	H106
Precitec Precision Machineries Pvt. Ltd	5	B107
Prime Technologies	5	B135
Pro B Products	5	B121

Company Name	Hall	Stall
Production Aids & Consultants Pvt. Ltd	5	C109a
Raj Petro Specialities Pvt. Ltd	5	B125
Renuka Engineering & Service	5	C136
Royal Tech Engineers	5	C144
S.M. Systems Pvt. Ltd	5	C132
Seoam Machinery Industry Co., Ltd	5	A141
Shilpa Enterprises	5	C146
Shilpin Machine Tools Pvt. Ltd	5	C108
Shradha Impex	5	A136
Signage Products	5	C126
SMC Pneumatics India Pvt. Ltd	5	B124
Solar Diamond Tools (India) Pvt. Ltd	5	A127
Solidcam Software India Pvt. Ltd	5	B122
Spepurmac Engineering Services	5	C124
Sphoorti Machine Tools Pvt. Ltd	5	A129
SPM Tools	5	B118
Square Engineering Works	5	A121
SriYantra Engineers Pvt. Ltd	5	A102
Statfield Equipment Pvt. Ltd	5	G104
Sterling Abrasives Ltd	5	K101
Super Hobs & Broaches Pvt. Ltd	5	F105
Suresh Indu Lasers Pvt. Ltd	5	B103b
Surya Machine Tools (India) Pvt. Ltd	5	C134
Suzhou Fulaike Cutting Tools Co. Ltd	5	B133
Swan Aluminiums Pvt Ltd	5	A140
Systemantics India Pvt. Ltd	5	A123
Tasa Micro SPM Pvt. Ltd	5	A128a
Tekcel Automation Pvt. Ltd	5	C107
Teknomec	5	A112
Toyoda Micromatic Machinery India Pvt. Ltd	5	B108
Tsi Power Pvt. Ltd	5	B120a
Tussor Machine Tools India Pvt. Ltd	5	A113
Ultramax Hydrojet Pvt. Ltd	5	H105
Unity Controls Pvt. Ltd	5	A132
Unity Gauge & Tool Co. Pvt. Ltd	5	C117
V. M. Traders	5	I102
Veeraja Industries	5	B131
Vinpak Machines Pvt. Ltd	5	C118
VPS Technology India Pvt. Ltd	5	A125
VW Mosbach CNC Technologies	5	C130
Wendt (India) Ltd	5	B117
XL CNC Machines	5	A115
Yugma Impressions	5	B110e

Hall 6

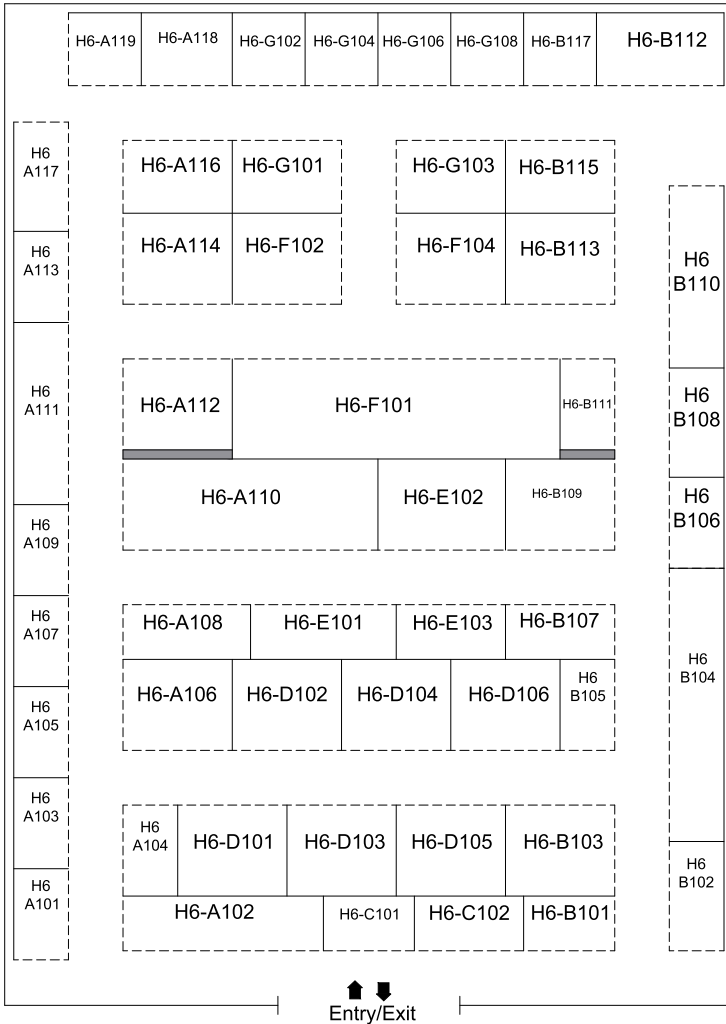
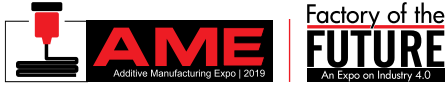

Company Name	Hall	Stall
Ace Micromatic Group - Industry 4.0	6	A110
Ace Software Solutions Pvt. Ltd - Industry 4.0	6	B111
Alstrut India Pvt. Ltd - Industry 4.0	6	G103
Altair Engineering India Pvt. Ltd - AME	6	A107
Altem Technologies (P) Ltd - AME	6	A119
Amace Solutions Pvt Ltd - AME	6	A110
Ascent Intellimation Pvt. Ltd - Industry 4.0	6	G106
ASI DataMyte India Pvt. Ltd - Industry 4.0	6	D104
Autodesk India Pvt. Ltd - Industry 4.0	6	A112
Big Zero Technology LLP - Industry 4.0	6	D106
Bosch Ltd - Industry 4.0	6	B115
Central Manufacturing Technology Institute - Industry 4.0	6	B104b
Conceptia Software Technologies Pvt. Ltd - Industry 4.0	6	G108
Cosmos Digifac - Industry 4.0	6	B103
Designcell CAD-CAM Solutions Pvt. Ltd - Industry 4.0	6	G102
DHI - Samarth Udyog Bharat	6	B104
EOS GmbH India Brach Office - AME	6	A106
FANUC India Pvt. Ltd - Industry 4.0	6	F104
Fractal Works Pvt. Ltd - AME	6	A108
Fraunhofer - Industry 4.0	6	D105
Future Technologies - Industry 4.0	6	A116
Harting India Pvt. Ltd - Industry 4.0	6	E102
HCL Technologies Ltd - Industry 4.0	6	A114
HP India Sales Pvt. Ltd. - Industry 4.0	6	B113
Ifm Electronic India Pvt. Ltd. - Industry 4.0	6	F102
IITD-AIA Foundation For Smart Manufacturing - Industry 4.0	6	B104c
Imaginarium Rapid Pvt. Ltd - AME	6	D101
Incredible AM - AME	6	E103

Company Name	Hall	Stall
Indian Institute of Science - Industry 4.0	6	B104d
Intech DMLS Pvt Ltd - AME	6	A111
Intouch Systems Pvt Ltd - Industry 4.0	6	B102
ISGEC Heavy Engineering Ltd - Industry 4.0	6	B105
Lakshmi Digi Pro Systemz - Industry 4.0	6	G104
Laser Automation Pvt. Ltd - AME	6	A102
Leanworx Technologies Pvt. Ltd - Industry 4.0	6	G101
Marposh India Pvt. Ltd - Industry 4.0	6	B109
Marshall Machines Ltd - Industry 4.0	6	B108
Multidimensions - AME	6	A118
Next Generation 3D Printers Pvt. Ltd - AME	6	A109
Pelf Infotech Pvt. Ltd - AME	6	A103
Pepperl+Fuchs Factory Automation Pvt. Ltd - Industry 4.0	6	B112
Quick Shape Pvt. Ltd - AME	6	A105
Rapid DMLS Inc. - AME	6	A104
Raplas India - AME	6	C102
Redington (India) Limited - AME	6	A117
Renishaw Metrology Systems Ltd - AME	6	D102
RV Forms & Gears LLP - Industry 4.0	6	B107
Samarth Udyog Technology Forum - Industry 4.0	6	B104a
Sandvik TDM - Industry 4.0	6	B101
Shree Rapid Technologies - AME	6	E101
Siemens Ltd - Industry 4.0	6	F101
Staubli Tec Systems India Pvt. Ltd - Industry 4.0	6	B110
Three Digi Prints - AME	6	A101
Trumpf (India) Pvt. Ltd - AME	6	D103
Vimana	6	B106
Wol 3d - AME	6	A113
Zentron Labs Pvt. Ltd - Industry 4.0	6	B117



**MODERN
MANUFACTURING
INDIA**

**Knowledge is power and
sharing knowledge is more powerful!**

The Official Magazine of



Indian Machine Tool
Manufacturers' Association

In Association with



WWW.MMINDIA.CO.IN



For Advertising contact: Murali Sundaram
murali.sundaram@mmindia.co.in | M: +91 9740048390

New Benchmarks in Economical Shaving and Gear Inspection

Gleason's new 200SVP Plunge Shaving Machine raises medium and high volume gear production to economical new levels, featuring a compact, rigid design and the latest Siemens CNC for easy operation.

See a preview of our IMTEX exhibits:

www.gleason.com/imtex



IMTEX 2019 HALL 5
BOOTH A124

Total Gear Solutions

Gleason



Mobil™

Industrial Lubricants



Advancing
Productivity™

RPM isn't just revolutions per minute. It's also Rupees per minute.

In a machine shop, time is money. And downtime is no money. To see how Mobil™ can enhance your profitability with its cutting-edge range of industrial lubricants, visit mobil.com/industrial

ExxonMobil Lubricants Private Limited

Bengaluru - 560048, India

Toll-free no.: 000-800100-8401 | indialubeline@exxonmobil.com

Visit us at Hall 5,
Stall No.: C119



Jan 24th - 30th 2019



Partner to the Indian Manufacturing Industry



Hall No.4, Stall No. A 106

LIEBHERR

Germany

Gear Grinding, Skiving, Hobbing,
Shaping Machines & Tools



Germany

Honing, Gun Drilling, Superfinishing Machines, Tool & Abrasives



AGATHON

SWITZERLAND
Switzerland

Indexable Insert Laser
& Grinding Machines



Spain

Precision CNC EDM Die Sinking
& Wirecut Machines



HEMBRUG
MACHINE TOOLS
Netherlands

Ultra Precision (<1μ) Hard
Turning Lathe and VTL



Japan

Precision CNC Optical Profile
Grinder



Germany

Ultra Precision (<1μ)
Vertical machining center



Germany

Spline, Thread and
Ring Rolling Machines & Dies



MARIO CARNAGHI
MILLING & TURNING CENTERS

Italy

Precision CNC Optical Profile
Grinder



Italy

Universal Testing &
Impact Testing Machines



An ITW Company

US & China

Hardness Testing Machines

FRANCIS KLEIN & CO. LTD.

Email: imtex2019@francisklein.in

Web: www.francisklein.in